

USER MANUAL
使用說明書

HITACHI

HITACHI FULLY AUTOMATIC WASHING MACHINE
日立全自動洗衣機

Model BW-V80FSP/FS



Thank you for your purchase of HITACHI Fully Automatic Washing Machine.

- Please read this manual carefully for proper operation.
- Please keep this manual for future reference.

承蒙您選購日立的全自動洗衣機，謹此致衷心謝意。

- 請細閱本說明書，以便正確使用本洗衣機。
- 閱讀完畢，請妥善保存本說明書，以備將來查閱。

CONTENTS

目錄

Key Features 前言.....	3
Safety Precautions 安全方面的注意事項.....	4
Installation Guide 安裝指南.....	7
Installation 安裝.....	11
Safety Check 安全檢查.....	12
Washing Machine Repair 洗衣機修理事宜.....	12
Technical Description 各部件名稱.....	13
Control Panel 控制面板.....	14
About the Lid Lock 關於機蓋緊鎖裝置.....	16
Preparing and checking clothes 準備和確認衣物.....	17
Professional washing 專業洗衣.....	18
How to Use Liquid Detergent, Bleach and Fabric Softener 洗衣劑、漂白劑、柔順劑的使用方法.....	19
How to select programs 洗衣程序的選擇方法.....	22
Select detergent 選擇洗衣劑.....	23
Washing 洗衣.....	24
Air Jet Program 風乾程序.....	26
Favour Program (design your own program) 個人設定程序（自己設計程序）.....	28
Blanket program 被毯程序.....	29
Gentle program 柔和程序.....	33
Delicate program 纖幼衣物程序.....	34
Washing in Your Favorite Way 按照您喜歡的方式進行洗衣.....	37
Auto Self Clean 自動筒清洗.....	42
Use Ultra-Stream Rinse 使用噴射沖洗.....	43
Preset 預校.....	44
Convenient usage methods 方便的使用方法.....	46
Maintenance 維修保養.....	48
Tub Clean·Tub Dry program 筒清洗·筒風乾程序.....	51
When Failure Happens 有故障發生時.....	53
Optional Parts 另售部件.....	60
Product Specifications 產品規格.....	60

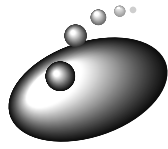

Key Features 前言

Water-saving circulating water flow 節水型循環水流

With little water in high efficiency

高效使用少量的水

The circulating water flow will come into being when stirring the water with the blades at the rear of stirring pulsator and combining sprinklers in three directions. Only small quantity of water will be sufficient to remove the dirt efficiently.

用葉輪的背面葉片攪動水流，通過上下 3 個方向的噴頭形成循環水，只需少量用水即可高效去污。

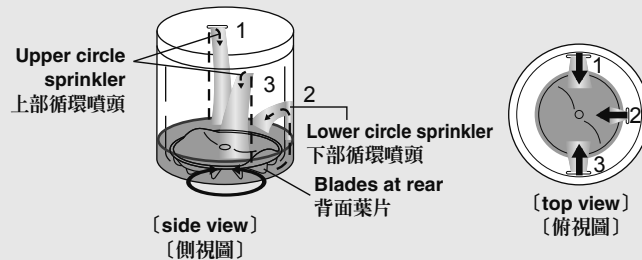

Circular Motion Penetration 迴旋滲透

Infiltrate the detergent inside the cloth to detach the dirt off the fiber.

使洗衣劑滲入到衣料內部，使污垢從布料纖維上脫落。

The detergent dissolves sufficiently to become the highly concentrated detergent that washes the laundry in infiltration mode for easier detachment of dirt off the cloth fiber.

洗衣劑充分溶解，形成高濃度洗衣液，對衣物進行滲透清洗，使污垢更易從布料纖維上分離。

- 1** Put detergent in, adding some water
加入洗衣劑，加入少量水
The detergent put in at the injection opening will fall below the pulsator.
從注入入口加入的洗衣劑將落在葉輪下方，並注入少量水。

- 2** Make the detergent dissolves fast by rotating the spinning basket.
通過脫水桶旋轉，加速洗衣劑溶解。

- 3** The detergent dissolves inside the cloth
溶解洗衣劑使其滲入衣物
The concentrated detergent dissolves with the agitating power of pulsator, and infiltrates sufficiently inside the cloth.
濃縮洗衣劑在葉輪強力攪拌下溶解，充分滲透到衣物內部。

- 4** THREE-STEP washing
三步洗衣
Inject a little water, and the dirt will detach with the highly concentrated detergent; inject more water to the normal water level for washing.
加入少量水，污垢在高濃度洗衣液下脫落，再加水到正常水位處進行洗衣。

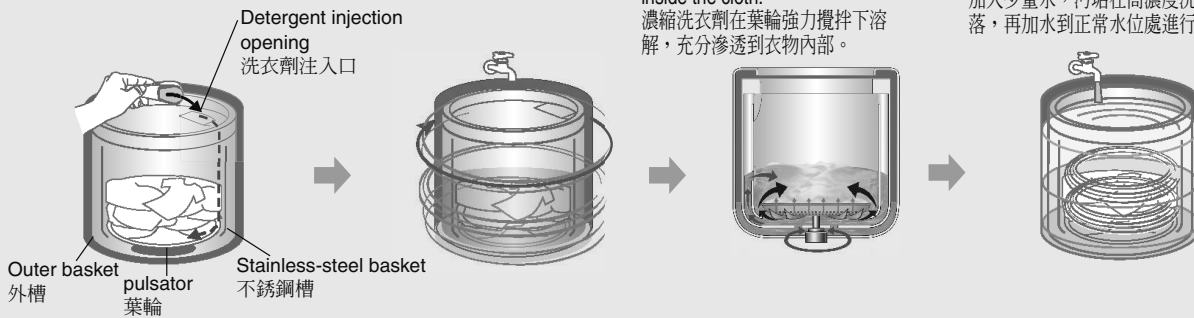

※ Please use concentrated powder detergent to wash.
請使用濃縮合成粉末洗衣劑進行洗衣。

Loosening & spinning 疏鬆脫水

In the last phase of spinning, execute the "Loosening process", so that the laundry can be easily taken out.

在脫水的最後階段，執行衣物的“疏鬆程序”，以便衣物易於取出。



※ Some washing capacity may not be available to execute.
有的洗衣量有可能無法進行疏鬆脫水。

※ The "Loosening process" does not perform in the case of manual setup of "RINSE", "SPIN" or "SPIN ONLY".
手動設定“沖洗”、“脫水”或“只脫水”等時，不執行衣物的“疏鬆程序”。

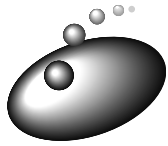

Safety Precautions

安全方面的注意事項

This appliance is intended to be used in household and similar applications such as: (IEC 60335-2-7) staff kitchen areas in shops, offices and other working environments; farm houses; by clients in hotels, motels and other residential type environments; bed and breakfast type environments; areas for communal use in blocks of flats or in launderettes.

本設備僅供家居使用，亦可用於下列類似用途：(IEC 60335-2-7) 店鋪、辦公室及其他工作環境之員工廚房；農舍；供酒店、汽車旅館及其他住宿類環境之客戶使用；提供床鋪及早餐類型環境；公寓樓房共享區域使用或自助洗衣店中。

Warning 警告



Dismantle, repair or alterations should be only carried out by professional technicians.

Dismantling Prohibited
禁止拆卸

除指定的專業維修人員外，絕對禁止他人拆卸、修理或改裝洗衣機。

- Avoid electric shock, fire, and body injury due to improper activity.
避免因不恰當行為而導致觸電、火災及人身傷害。



Please use the single socket with 220V~,13A specification.

請單獨使用額定值為交流220V~，13A以上容量的電源插座。

Power 電源

- The share of the same socket with other electric appliances may cause fire due to excessive heat.
若與其它電器設備共用同一插座，可能因異常發熱而導致火災事故。

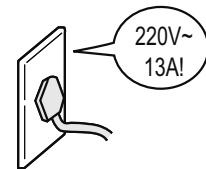

Grounding
接地連接

This washing machine is equipped with the electricity wire with bi-electrode grounding plug, please use the bi-electrode grounding socket.

The creepage protector shall be used if possible.

本品採用二極接地插頭電源線，請使用二極接地電源插座。可能的話，最好使用漏電保護器。

- To prevent electricity leak which may cause injuries.
避免因漏電故障引起傷害。



Humid places prohibited
禁止潮濕的地方

Washing machine should not be installed in humid place or in places exposed to wind and rain.

請勿將洗衣機安裝在潮濕或容易受到風吹雨淋的地方。

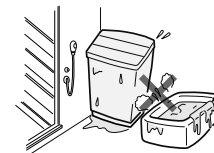

- Otherwise, electricity leak causing electric shock or fire may occur.
避免觸電或因漏電而引發火災事故。



Wet hands Prohibited
禁止濕手觸摸

Electricity supply must be unplugged / plugged with dry hands.
嚴禁使用濕手插拔電源插頭。

- Otherwise, this may cause electric shock.
否則可能導致觸電事故。

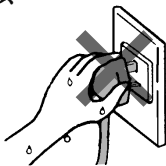

Prohibited
禁止

Do not put water in direct contact with the unit during maintenance and repair.

進行保養時，請勿直接將水淋灑在洗衣機的各個部位。

- This may cause short circuit or electric shock.
否則可能造成短路或觸電事故。

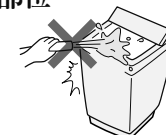

Prohibited
禁止

Do not put your hand into the basket until it has stopped completely.

在脫水槽完全停止轉動前，嚴禁將手伸進槽內拿取衣物。

- Even when the spinning of the basket is slow, there is still a danger of being caught in the motion, resulting injuries. Particular attention should be paid when children are around.
即使旋轉緩慢，手部仍有被衣物纏繞的危險。兒童尤需注意。

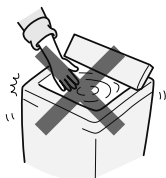

Prohibited
禁止

Do not put your hands into the washing · spinning basket during the washing and rinsing processes.

洗衣和沖洗過程中，嚴禁將手伸入洗衣·脫水槽內。

- Even when the spinning is slow, hands may be trapped by clothes. If necessarily, please press pause button, and put your hands into the washing · spinning basket after it has stopped completely.
即使旋轉緩慢，手部仍有被衣物纏繞的危險。（若必須將手伸入槽內時，請按下暫停按鈕，待洗衣·脫水槽完全停止旋轉後再伸入槽內）。

⚠ Warning 警告



Prohibited
禁止

Damaged or loosen wire or plug should not be used.
嚴禁使用已損壞的電源線、插頭或鬆動的插座。

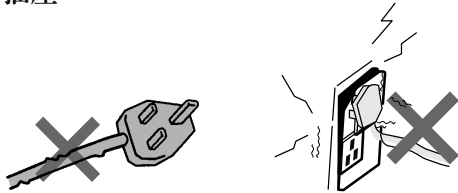

- Otherwise electric shock, short circuit or fire may take place.
否則可能導致觸電、短路或起火。
- If the power supply cord is damaged, Please repair it in a repair shop appointed by the manufacturer or its service agents in order to avoid a hazard.
電源線破損時，請到廠商指定的店鋪修理，以免危險。



Prohibited
禁止

Do not damage wire.
嚴禁損壞電源線。

Do not damage or alter the wire forcibly bend, pull, twist or handle the wire. Besides that, please do not put heavy object on or trap the wire.
請勿隨意進行改裝、強行彎曲、拉伸、扭曲及捆紮電源線。此外，亦請勿將重物壓在其上或夾於其中。



- Damage of wire may cause electric shock or fire.
若電源線遭受損傷，可能導致觸電或火災。



Prohibited
禁止

Keep child away from the washing • spinning basket and do not place box or shelves next to the washing machine.
嚴禁讓兒童探看洗衣 • 脫水槽。也請勿在洗衣機旁放置台架等物品。

- Children should be supervised to ensure that they do not play with the appliance.
請督導兒童，確保其不玩耍機器。
- Children may fall into the washing • spinning basket resulting in injuries.
兒童可能因掉入洗衣 • 脫水槽中造成人身傷害。



Clear
清掃

Thoroughly wipe the power plug when dirt is adhering the prong or around the base of the prong.

電源插頭的插片以及插片的夾緊面上，若有塵垢附著時，請擦拭乾淨後再使用。

- Failure to do so may cause a fire.
可能會引起火災。

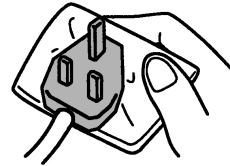

No smoke or fire
禁止煙火

This washing machine is strictly prohibited from being placed close to the locations with candle, mosquito-repellent incense, dog-end or other kinds of open flame.
本洗衣機嚴禁靠近蠟燭、蚊香或煙頭等有明火的場所。

- To avoid injuries caused by the lock installation damage.
避免因裝置損壞而引致傷害。



Prohibited
禁止

Do not put gasoline, benzene, alcohol, thinner of fabrics with these stains into or near to the washing machine.
請勿將汽油、煤油、酒精、稀釋劑或沾有上述液體的衣物放入槽內或靠近洗衣機。

- To prevent fire or explosion which may cause injuries.
否則可能引發爆炸或火災事故。

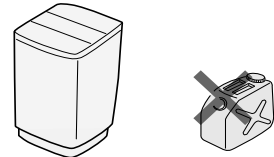

Prohibited
禁止

Do not insert a screwdriver into the Lid Lock hole.
嚴禁用螺絲刀插入洗衣機機蓋緊鎖裝置部位的孔內。

- To avoid injuries caused by the lock damage.
避免因裝置損壞而引致傷害。

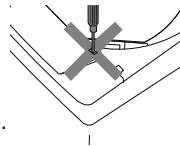

Prohibited
禁止

Do not open the lid in locked status by force.
嚴禁強行打開處於鎖定狀態的機蓋。

- Otherwise, the lid or locking device may be damaged, resulting in unstoppable spinning of washing • spinning basket and thus causing injuries.
否則將會損壞機蓋或鎖緊裝置，導致洗衣 • 脫水槽無法停止旋轉，造成人身傷害。

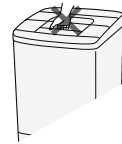

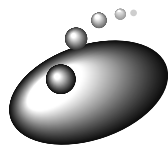

Safety Precautions (continued) 安全方面的注意事項 (續)



Attention 注意

<p>Prohibited 禁止</p> <p>Do not pull the wire from the socket when unplugging the unit. 拔掉電源插頭時，切勿拉扯電源線，必須拿住插頭本體向外拉。</p> <p>• To avoid electric shock or fire cause by short circuit may result. 避免觸電或因短路導致火災事故。</p> 	<p>Prohibited 禁止</p> <p>Do not stand on or put heavy object on the top of the unit. 請勿站立在洗衣機上，或者在其上放置重物。</p> <p>• Otherwise, deformation or damage may result causing injuries. 可能因變形或損壞造成人身傷害。</p> 
<p>Prohibited 禁止</p> <p>Do not connect to the hot water supply. And, water of above 60°C should not be used for washing. 請勿連接至熱水管，並且用溫水進行洗衣時，水溫嚴禁超過60°C。</p> <p>• Electric shock or leakage may occur due to deformation of plastic parts of the unit. 可能因塑膠部件的變形受損而導致觸電或漏電事故。</p> 	<p>Prohibited 禁止</p> <p>Keep hands and feet away from the bottom of the washing machine when it is in motion. 運轉過程中，請勿將手或腳伸至洗衣機的下部。</p> <p>• Parts in motion beneath the unit may cause injuries. 旋轉部件可能會引起人身傷害。</p> 
<p>Prohibited 禁止</p> <p>Please unplug the unit when not using the unit for a long period of time. 不使用洗衣機時，必須將電源插頭拔出。</p> <p>• Electric shock or leakage due to aging of insulator may cause fire. 可能因絕緣老化而引發觸電、漏電或火災事故。</p> 	<p>water leakage 漏水</p> <p>Water supply hose should be tightly screwed to the unit. 供水管連接機體的絲母必須擰緊。</p> <p>• Failure to do so may result in water leakage. 可能導致漏水。</p> <p>• After being used for a long period of time, the unit may result in water leakage caused by loosen union nut. So please check it in time and screw tightly again. 長期使用後，可能會因連接絲母鬆動造成漏水而遭受不必要的損失。因而請務必定期檢查並重新擰緊已鬆動的絲母。</p> 
<p>water leakage 漏水</p> <p>Check water supply hose connection by turning on the water tap before washing. 開始洗衣前，請先打開水龍頭，檢查供水管的連接狀況。</p> <p>• To prevent damages caused by possible water leakage due to loosen screw. 如果螺釘鬆脫，會因漏水而招致不必要的損失。</p> 	<p>Prohibited 禁止</p> <p>When installing the washing machine, be sure to draw out the water drainage hose until the mark is seen. 安裝洗衣機時，請務必將排水管拉出至標記處。</p> <p>• Failure to do so may cause damage to the drainage hose and water leakage. 如果排水管沒有完全拉出，會與其它部件觸碰而導致破損，引發漏水等意想不到的損失。</p> 
<p>water leakage 漏水</p> <p>Please turn off the water tap when not using the unit. 不使用洗衣機時，必須關閉水龍頭。</p> <p>• To prevent damages caused by water leakage. 以防產生漏水。</p> 	<p>Prohibited 禁止</p> <p>Do not wash, rinse and spin the water-proof fabric or cloth. 請勿洗滌防水性的布料或衣物。</p> <p>(sleeping bag, raincoat, cover of skiing utilities, bicycles, cars and motors 睡袋、雨衣、滑雪用具以及自行車、轎車、摩托車的車罩等。)</p> <p>• Otherwise may lead to injury by abnormal vibration during spinning or damage the washing machine, wall, floor and clothes. 可能在脫水時產生異常振動而引起人身傷害，或者導致洗衣機、牆壁、地板以及衣物的損壞。</p> 
<p>Prohibited 禁止</p> <p>Do not slant the washing cap. Do not use the washing cap except BLANKET, DELICATE program. 嚴禁傾斜安裝洗衣蓋，並絕對禁止在「被毯」、「纖幼衣物」程序以外使用洗衣蓋。</p> <p>• Splash of water may occur or washing cap may be swung out of the basket. 可能會因水滴飛濺或洗衣蓋彈飛出造成洗衣機受損或人身傷害事故。</p> 	

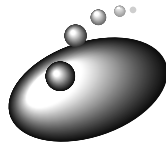

Installation Guide 安裝指南

Installation of Washing Machine 洗衣機的安裝

Where to install 安裝地方

Please install on a solid horizontal surface.

請安放在堅硬、平的地面上。

- Installation on a slippery or irregular surface may result in noise and shaking.
安放在易於滑動、凹凸不平的地面上，會容易產生振動和噪音。

Avoid installing the unit too close to the wall.

請勿靠近牆壁安裝。

- This is to prevent abnormal vibration and noise.
以防止異常振動和噪音。

How to install 安裝方法

The unit should be installed on a flat horizontal surface.

請水平安裝洗衣機。

Otherwise sudden stop or abnormal sound may occur during the spinning cycle.

若安裝得不水平，會導致脫水時停機或產生異常聲音。

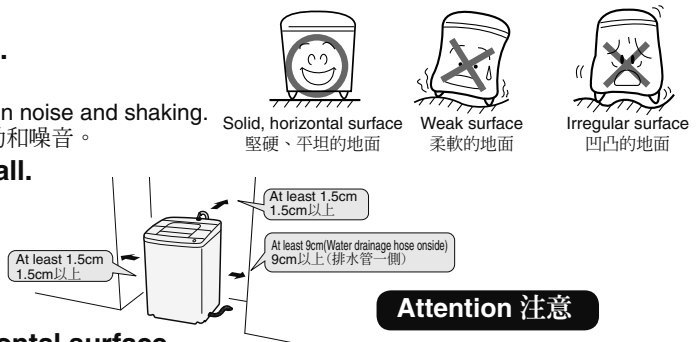

Attention 注意

- Carpet should not obstruct the openings for washing machines with ventilation openings in the base.
地毯不要堵塞通風口。

1 Put the washing machine at the installation place.

把洗衣機放置在安裝場所。

- Make adjustment according to the following steps if the washing machine is not put on a flat horizontal surface or there's gap under the leg:
如果洗衣機放置得不平、機腳下有間隙，可按照下述步驟調節：
- Heighten the adjustable leg till no gap exists at its side.
可調機腳一側有間隙時調高可調機腳，消除間隙。
- If there's gap opposite to the adjustable leg, make the rear leg stand closely on the ground, and insert proper plank between the front leg and the ground to fill up the gap.
可調機腳的對面一側有間隙時讓後側的腳著地，用適當的板材鋪墊在前側的腳與地面之間，消除間隙。

3 According to the bubble location on the horizontal indicator, rotate the adjustable leg to locate the bubble at the circle center.

根據水平儀的氣泡位置，旋轉可調機腳，使氣泡至於圓圈中央。

If the bubble is out of half of the circle radius, the ground is too sloppy to be regulated to flat with only the adjustable leg. The plank shall be properly inserted.

如果氣泡偏出圓圈一半以上，那就是地面的傾斜度太大，已經不能單用可調機腳調節。可用適當的板材鋪墊。

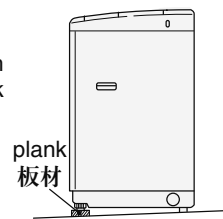

2 Check the bubble location on the horizontal indicator.

檢查水平儀的氣泡位置。

- No leg adjustment is required if the bubble is right at the circle center.
如果氣泡正好在圓圈的中央，腳就不需要調節。

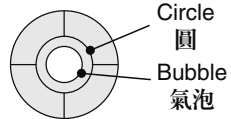

Observe the horizontal indicator from above.
※要從上方看水平儀。

- Adjust height with the adjustable leg if the bubble is not in the circle.
如果氣泡不在圓圈中，用可調機腳調節高度。

4 Check the existence of gap under the washing machine leg.

檢查洗衣機腳下是否有間隙。

- If gap exists, adjust the adjustable leg.
如果有間隙，用可調機腳進行調節。

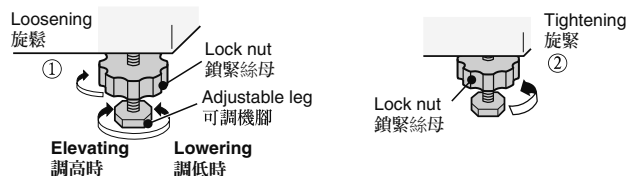

5 Remove the horizontal indicator. Close the lid.

取出水平儀，關閉機蓋。

Installation of the bottom plate 底板的安裝

The bottom plate is placed on the packaging foam on the top of the washing machine.
出廠時，底板安放在洗衣機頂部的包裝發泡膠上。

1 Please lay down the washer slowly.

請將機體輕輕地放倒。

2 Align the hook on the bottom plate with the square hole on the chassis and insert it, and then tighten the screw.

將底板上的倒鉤對準底盤上的方孔插入，然後擰緊螺釘。

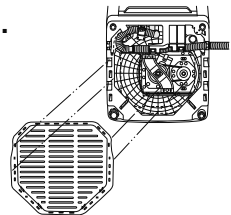

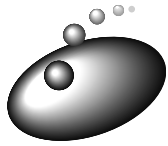

Installation Guide (continued) 安裝指南 (續)

How to Install the Water Supply Hose 供水管的安裝

Connecting the water supply hose to the washer 供水管與機體的連接

Firmly tighten the union nut when connecting the water supply hose to the water inlet.
沿箭頭方向旋轉連接絲母，使其與供水口緊緊相連。

- Loosely tightened union nut will cause water leakage. 請務必擰緊供水管與機體的連接絲母。否則，將會漏水。
- When removing the hose, unscrew the union nut first. 拆卸供水管時，先鬆開連接絲母，再進行拆卸。

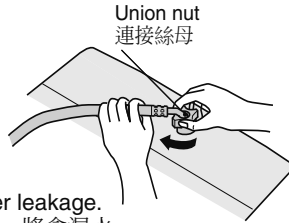

Extending the water supply hose 供水管的延長

Please use optional extension pipe to extend length of the water supply hose.

請使用另行銷售的延長供水管。

- Three standard extension hoses (1m, 2m, 3m) are available. Please inquire distributors for extending the water supply hose. 備有1m、2m和3m三種規格供購買。如欲延長供水管，請向銷售商查詢。

How to Install the One Touch Joint 便捷連接器的安裝

1 Confirm the diameter of the water tap. 確認水龍頭直徑。

- If the diameter exceeds 2cm, remove the joint ring. 若水龍頭的外徑超過2cm，可將連接環取出。

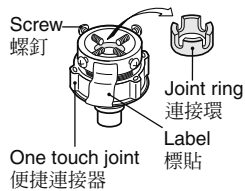

2 Check the distance between joints A and B. 確認接頭A、B之間間隙。

- Screw joint B in the arrow direction to adjust the gap. 沿箭頭方向旋轉接頭B調整間隙。

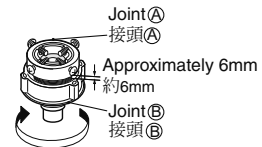

3 Press the sealed pad evenly against the tap and tighten the four screws uniformly. 將密封墊均勻地壓在水龍頭上，再將4個螺釘均等地擰緊。

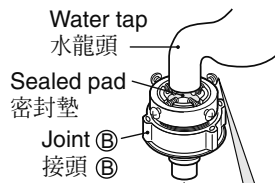

Tighten screw in advance if it is located close to the wall. 靠近牆壁的螺釘，可預先用手擰進一些。

4 Tighten joint B in the arrow direction to reduce the gap between joint A and B to 4mm or less. 沿箭頭方向擰緊接頭B，使接頭A、B之間間隙在4mm以內。

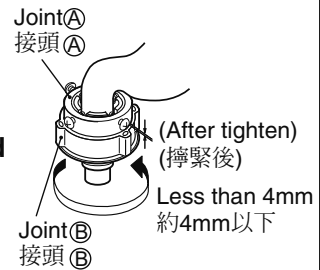

- For water supply hose installation, please refer to "How to install the water supply hose" in the user manual. 供水管的安裝參閱使用說明書中「供水管的安裝」一章。
- Loosening may occur after a long time use. In such a case, reinstall the joint following steps 2 to 4. 長時間使用後，可能會因鬆脫而引起漏水，此時請按2-4的步驟重新安裝。
(Follow the same steps when reinstalling the one touch joint when you move the machine to another location.)
(搬家等需重新安裝便捷連接器時，請按照相同的步驟進行。)

Appropriate water tap 適用的水龍頭

Horizontal taps A and B as shown below. 橫式A、B型水龍頭最為適宜。

Horizontal tap A
橫式A型水龍頭



Horizontal tap B
橫式B型水龍頭



Square mouth tap
方口水龍頭

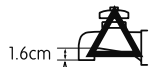

Distance must be over 1.6cm in order to install correctly. 若無1.6cm以上的距離將無法安裝。

Universal household tap
萬能水龍頭

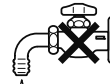

May break off after installing the one touch joint. 便捷連接器安裝後，可能會脫落。

Swivel tap
萬向水龍頭



Water leakage may occur. 有可能會漏水。

How to Install the Water Drainage Hose 排水管的安裝 (BW-V80FS)

■ The water drainage hose is installed at the factory on the right side. It can be moved to the left side if necessary.

產品出廠時，排水管安裝在機身右側，請視排水位置的具體情況將其換至左側。

- 1 Lay the unit down slowly.** 請將機體輕輕地放倒。
- Lay the unit down on some corrugate paper to prevent damage. 放倒機體時，請在地面上放置一些瓦楞紙類的襯墊，以免損傷機身。

- 2 Pull out the water drainage hose from the left side of the unit.** 排水管從左面引出。

- ① Remove the left water drainage hose cover. 將機體左面的排水管蓋拆下。
- ② After pulling out the mark of the water drainage hose from the right groove of the unit, the mark of the water drainage should be inserted into the corresponding groove of the left unit. 把排水管標記部從機體右側的凹槽內引出，標記部應嵌入機體左側對應的凹槽內。
- ③ The water drainage hose should be pulled out through the proper hose clamps when the hose is pulled out on the left. 排水管從左面引出時，排水管應通過相應的軟管固定夾後再引出。

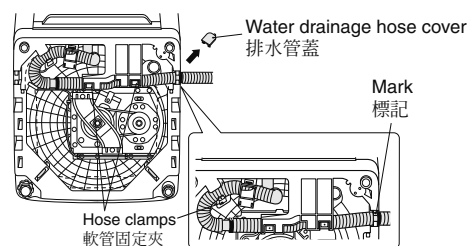

⚠ Attention 注意



The mark of the water drainage hose should be inserted into the corresponding groove of the unit.

安裝洗衣機時，請務必將排水管的標記部嵌入機體相對應的凹槽內。

- Water drainage hose which inserts into the unit, cannot touch other parts, to prevent the damage caused by water leakage. 排水管在機體內的部分，不應與其它部件碰觸，以免因破損產生漏水而導致不必要的損失。
- Water drainage hose clamp must be tightened. 排水管固定夾必須夾緊。
- The inner section of the water drainage hose must be secured by the clamp before being fetched out. 排水管機內部分必須經固定夾固定後再引出。

■ When fitting the water drainage hose to the water drainage outlet

排水管插入排水口時

If the water drainage outlet is too shallow or the end of the water drainage hose touches the grounds, cut the end of the water drainage hose in an oblique angle.

排水口較淺或排水管前端與地面碰觸時，可將排水管的前端沿斜向切除一部分。

- Failure to do so may cause insufficient rinsing or unit malfunction due to poor drainage or too much bubbles during rinsing and spinning.

若不切除，在沖洗及脫水時，由於排水狀況的不良，將會引起沖洗不充分或因肥皂沫而影響電機運轉。

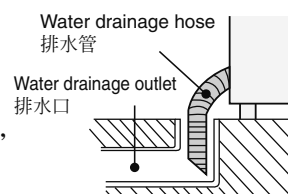

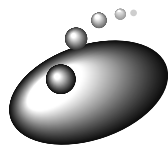

Installation Guide (continued) 安裝指南 (續)

How to Install the Water Drainage Hose 排水管的安裝方法 (BW-V80FSP)

1 Connect the water drainage hose with the water drainage joint on the back of the body.
將排水管連接到機體背後的排水接頭上。

- Fully insert it into place to avoid leakage.
應切實地插入到位，以免漏水。

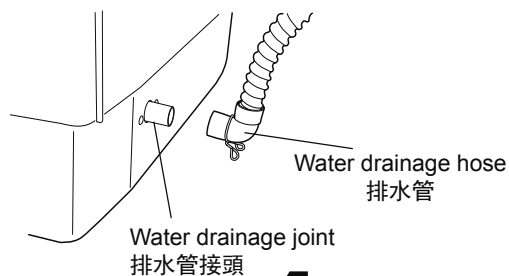

2 After the connection is completed, please use hose clipper to clamp the water drainage hose to avoid fall-off.
連接完成後，請用軟管夾子將排水管夾住以防止掉落。

- Use hose clipper to clamp the water drainage hose to avoid fall-off.
用軟管夾子將排水管夾住以防止掉落。

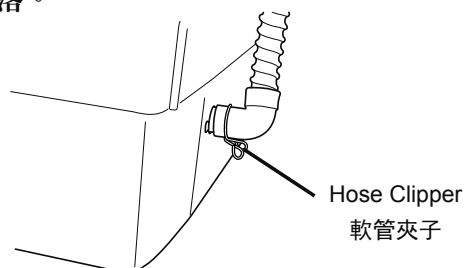

3 ① Insert the fixing holder of water drainage hose into claws clasp on either side of back side of top cover.
將排水管固定架插入面框後方任意一側爪扣中。

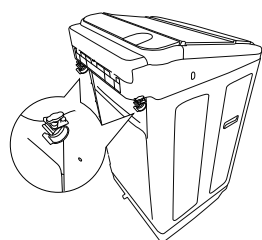

4 Pull the water drainage hose straight, concave to fix into the fixing holder of water drainage hose.
將排水管拉直，嵌入固定在排水管固定架上。

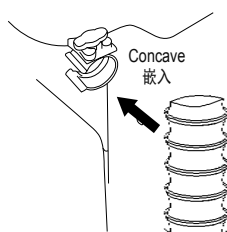

Water drainage hose from the right or (left) side of the unit.
排水管從右側 (或左側) 引出。

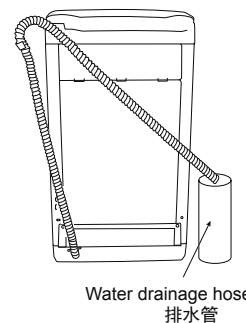
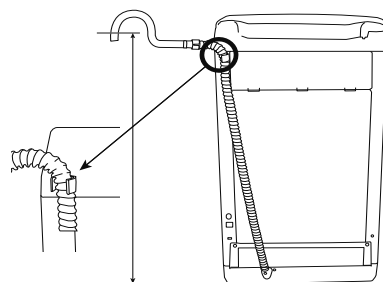

Unplug U-shaped hose and insert into water drainage hose.
拔去 U 形管插入排水管中。

Attention 注意

- To avoid direct draining due to the fallen water drainage hose, the water drainage hose must be used only after installing into fixing holder, and its hanging height should not exceed 1m.
為了避免排水管掉落造成直接排水，請務必將排水管嵌入固定架後再進行使用，且排水管的掛靠高度不應超過 1 米。
- Do not release the water drainage hose lest the water is splashed.
請勿將排水管放倒，以免水洒落。
- Do not use extended water drainage hose.
請勿使用延長排水管。
- Do not immerse the U-shaped hose on the tail of the water drainage hose in the water.
請勿將排水管尾部的 U 型管浸沒在水中。
- When using it in winter, to prevent icing, please release the water drainage hose after using and place its tail in water container such as basin, set the washer to single dehydration mode and drain the remained water.
在冬季使用時，為防止結冰，使用結束後，請將排水管放倒，並將其尾部放入水盆等盛水容器，設定洗衣機為單脫水，將殘留的水排乾。
- Be sure not to install the water drainage hose at a position lower than water drainage joint, otherwise, it could lead to difficulties in water drainage.
排水管安裝時，請勿低於排水接頭，如低於排水接頭可能會導致排水不暢。

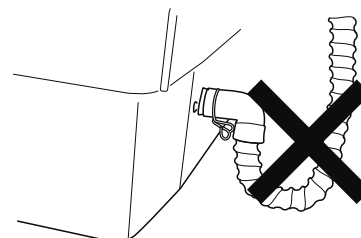

※ This discharge pipe installs the method to be only suitable in BW-V80FSP.
此排水管安裝方法只適用於 BW-V80FSP。

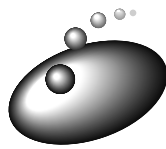

Installation 安裝

⚠ Attention 注意



Please turn on the water tap to check to connecting condition of the water supply hose before washing.

開始洗衣前，請先打開水龍頭，檢查供水管的連接狀況。

- To prevent damages caused by water leakage due to loose screw.
如果螺釘鬆脫，會因漏水而招致不必要的損失。

How to install and remove the water supply hose 供水管的安裝方法和拆卸方法

Water tap 水龍頭

Do not allow water tap, one touch joint and rubber ring to touch the washing machine when installing them.
安裝水龍頭、便捷連接器以及滑環時，注意別讓它們碰到洗衣機機體。

■ Installing 安裝方法

1 Push down the rubber ring and insert the tap into the one touch joint.
將滑環下壓，然後插入便捷連接器內。

2 Release the rubber ring and push up the water supply hose until it clicks.
放開滑環，向上推壓供水管，直至發出“叭”的鎖緊聲為止。

- Pull the water supply hose to confirm that it does not come off easily.
拉一拉供水管，確認供水管不會脫落。

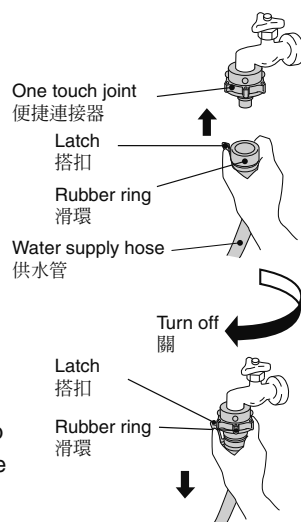

■ Removing 拆卸方法

1 Turn off the water tap.
關閉水龍頭。

2 Press the start button and let the machine run for about ten seconds.
按下啟動按鈕，運轉10秒鐘。

- This is to prevent water splashing when removing the tap.
為了防止拆卸時水花四濺。

3 Remove the latch and the water supply hose while pushing down the rubber ring.
鬆開搭扣，拉下滑環，同時將供水管拔下。

Main unit 機體

Turn the union nut in the direction as shown by the arrow and firmly connect it to the water inlet.

沿箭頭方向旋轉連接絲母，使其與供水口緊緊相連。

⚠ Attention 注意



Firmly tighten the union nut when connecting the water supply hose to the water inlet.

- Please be sure to tighten the water supply hose to the water inlet.
請務必旋緊供水管與供水口的連接絲母。
- Failure to do so may result in water leakage.
絲母鬆脫的話，可能會漏水。



- Loosely tightened union nut will cause water leakage.
連接絲母如不擰緊，可能產生漏水現象。
- When removing the hose, unscrew the union nut first.
拆卸時，擰下連接絲母，即可拆除。
- Please use the water supply hose and one touch joint supplied in the package.
請使用隨機配套的供水管和便捷連接器。
- The appliance is to be connected to the water mains using new hose set and that old hose-set should not be reused.
應使用附帶的新的連接水管進行連接，舊的連接水管不得再次使用。

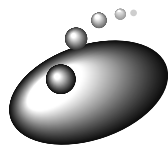

Safety Check 安全檢查

If any of the following conditions or other abnormalities occur, immediately pull out the power plug to prevent an accident and request help from an authorized dealer or agent.

如出現下列情況或其它異常現象，請立即拔下電源插頭，務必向有關的經銷商委託檢查、修理。（可能根據實際情況收取費用）

- Never conduct repairs by yourself as it may be dangerous.
請勿自行維修，以免發生危險。
- If you have used the washing machine for 4 - 5 years, even if the following conditions and other abnormalities do not occur, request for safety inspection of the machine is still required.
使用超過4 - 5年的洗衣機，即使沒有出現下列情況或其它異常現象，亦請進行安全檢查。
- If the power supply cord is damaged, Please repair it in a repair shop appointed by the manufacturer or its service agents in order to avoid a hazard.
電源線破損時，請到廠商指定的店鋪修理，以免危險。
- The washing machine is not to be used by children or persons with reduced physical, sensory or mental capabilities, or lack of experience and knowledge, unless they have been given supervision or instruction.
兒童、殘疾人士、智障人士在沒有監管和指導的情況下請勿使用本品。
- The washing machine should have ventilation openings at the base.
The washing machine bottom must not be obstructed by carpet when the washing machine is installed on a carpet floor.
洗衣機的底部應保持通風。
安置洗衣機時，請勿因地毯而妨礙洗衣機的底面安置。

- When you turn on the switch, the machine sometimes does not operate.
若打開開關，洗衣機或會停止運作。
- The power cord has "cracks" or "flaws".
電線出現損毀或裂痕。
- There are abnormal sounds and vibrations during operation.
運行過程中發出異常聲音或震動。
- The pulsator does not stop easily. (It takes over 15 seconds for the pulsator to stop)
葉輪不易停止。（停止葉輪需要15秒鐘以上）
- There is water leakage. (Basket, hose, joint, etc.)
漏水。（洗衣槽、水管、接頭等）
- There is a smell of burning.
有燒焦味。
- If you touch the machine, you may get an electric shock.
用手觸摸時，有電擊的感覺。

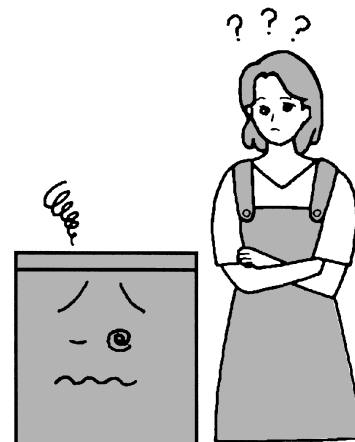

In case when the washing machine is used in places other than ordinary households.

在一般家庭以外使用時

- If the washing machine is in use for extremely long periods of time compared to ordinary household usage, such as in dormitories and hospitals, it may be necessary to change parts (such as the clutch, belt or sealed pad) more frequently. In this case, consult with the dealer from whom you purchased the washing machine and have the machine inspected periodically.
如在宿舍或醫院等地方使用，而每天的使用時間比一般家庭較長時，或需在短期內更換零件（如離合器、皮帶、密封墊等）。請與購買洗衣機的商店聯絡，接受定期檢查後再使用。



Washing Machine Repair 洗衣機修理事宜

In case of malfunction of the washing machine, read the manual in detail before requesting repair services. If the problem still cannot be solved, contact the authorized service centre and provide the following information.

- ① Model name: BW-V80FSP/FS.
- ② Describe abnormal situations and damages in detail.
- ③ Your address and telephone number.

若洗衣機在使用期間發生故障，在請求維修前，請務必詳閱本說明書。若發生的故障或異常情況未能用本明書的指示解決，請與認可的維修服務店聯絡。請向維修服務店提供下列資料：

- ① 產品型號：BW-V80FSP/FS。
- ② 盡可能詳細的說明故障狀況或異常情況的內容。
- ③ 您的聯絡地址和電話號碼。

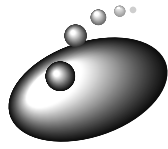

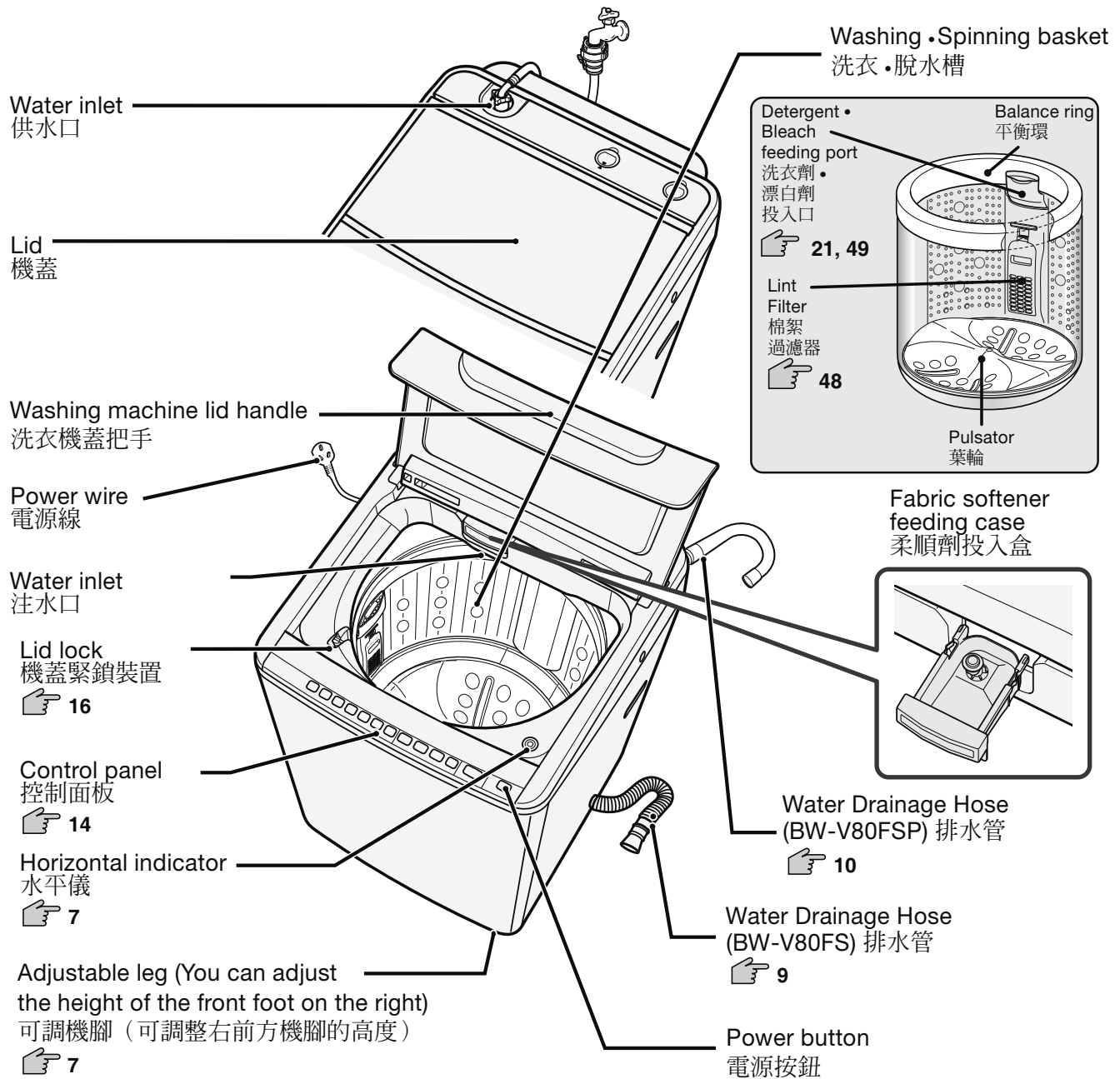

Technical Description 各部件名稱

The number next to the sign is the page number for detailed description.
後面的數字表示詳細說明的頁數

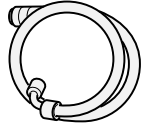
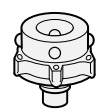
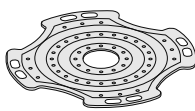
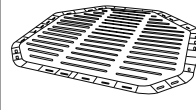

Accessories (Please refer to the "Installation Guide") 附件 (請參照「安裝指南」)

<p>Water supply hose 供水軟管</p>  <p>(One) (About 0.8m) (1 條) (約 0.8 米)</p>	<p>One touch joint 便捷連接器</p>  <p>(one) (1 個)</p>	<p>Washing cap 洗衣蓋</p>  <p>(One) (1 塊)</p>	<p>Base plate (Screws include) 底板 (帶螺釘)</p>  <p>(One) (1 塊)</p>	<p>Water Drainage Hose 排水管</p>  <p>(One) (1 條) (Suitable in BW-V80FSP) (適用 BW-V80FSP)</p>	<p>Fixing holder of water drainage hose 排水管固定架</p>  <p>(One) (1 個) (Suitable in BW-V80FSP) (適用 BW-V80FSP)</p>
---	---	---	---	--	--

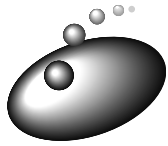

Control Panel 控制面板

Wash using soaking programs 用浸泡程序洗衣

When the "Soak" button is pressed, the lights will be turned on according to the time sequence.
按下「浸洗」按鈕後，將按時間順序亮燈。

Select washing program 選擇洗衣程序 →(P.24~36)

When the "Program" button is pressed, all program indicator lights will turn on, with the light for the selected program flashing.
按下「程序」按鈕後，所有程序亮燈，選中的程序閃爍。
When the "Start/Pause" button is pressed, only the light for the selected program will turn on.
按下「啟動/暫停」按鈕後，僅選中的程序亮燈。

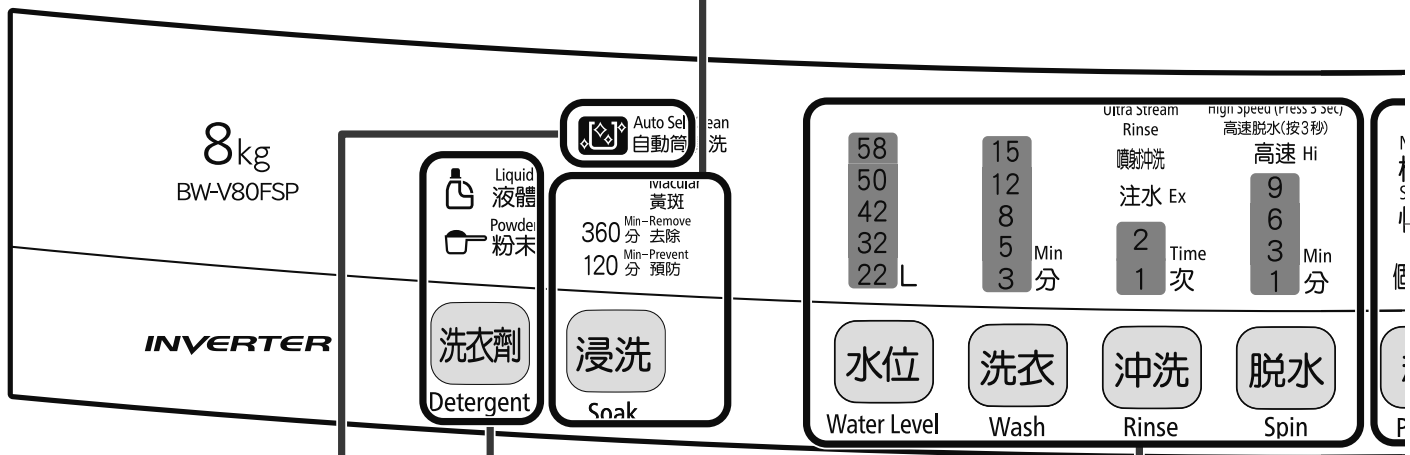

Set to Auto Self Clean 設定為自動筒清洗 →(P.42)

Automatically cleans stains from the rear side of the washing basket as well as other areas that cannot be seen.
自動清洗洗衣槽背面等看不見的部位之污漬。

Select Detergent 選擇洗衣劑 →(P.23)

Select powder detergent or liquid detergent.
選擇粉末洗衣劑或液體洗衣劑。

Change operation specifics 更改洗衣內容 →(P.38~41)

The "Wash", "Rinse", and "Spin" settings can be changed.
可更改「洗衣」、「沖洗」、「脫水」設定。
They may not be changeable during some programs.
有些程序可能無法更改。

■ Press button for few seconds to change setting (長按按鈕數秒改變設定)。

浸洗 Soak	activate or de-activate Auto Self Clean. 設定或解除自動筒清洗。	→(P.42)	程序 Program	activate or de-activate child lock. 設定或解除安全保護模式。	→(P.16)
水位 Water Level	activate or de-activate high water level. 設定或解除增加用水量。	→(P.47)	沖洗 Rinse	extend the time for rotation, water insertion, and rinsing. 延長噴淋沖洗時間。	→(P.47)
脫水 Spin	activate or de-activate high-speed spinning. 設定或解除高速脫水。	→(P.47)			

**Perform Air Jet、Tub Dry
進行風乾、筒風乾
→(P.26、51)**

When the "Air Jet" button is pressed, the lights will turn on according to the time sequence. 按下「風乾」按鈕後，將按時間順序亮燈。

**Lid lock display
機蓋緊鎖顯示
→(P.16)**

🔒 (Lid lock)
🔒 (機蓋緊鎖)
The light turns on when the lid is locked 機蓋鎖定時亮燈。
🔒 機蓋緊鎖
Both lights turn on when the lid lock is activated. 安全保護模式設定時同時亮燈。

**Time remaining-amount of detergent
剩餘時間·洗衣劑量·預校時間·通知顯示
→(P.19、41、44、53)**

After operation commences, the estimated time remaining and the amount of detergent are displayed. 開始洗衣後顯示參考剩餘時間和洗衣劑量。

- Each time the "Preset" button is pressed, the preset time schedules are displayed. 每按一次「預校」按鈕，即顯示預校設定時間。
- The notifications issued during operation will be displayed. 將顯示洗衣過程中發生的通知內容。 For example: C2, Ch, etc. 例：C2、Ch等

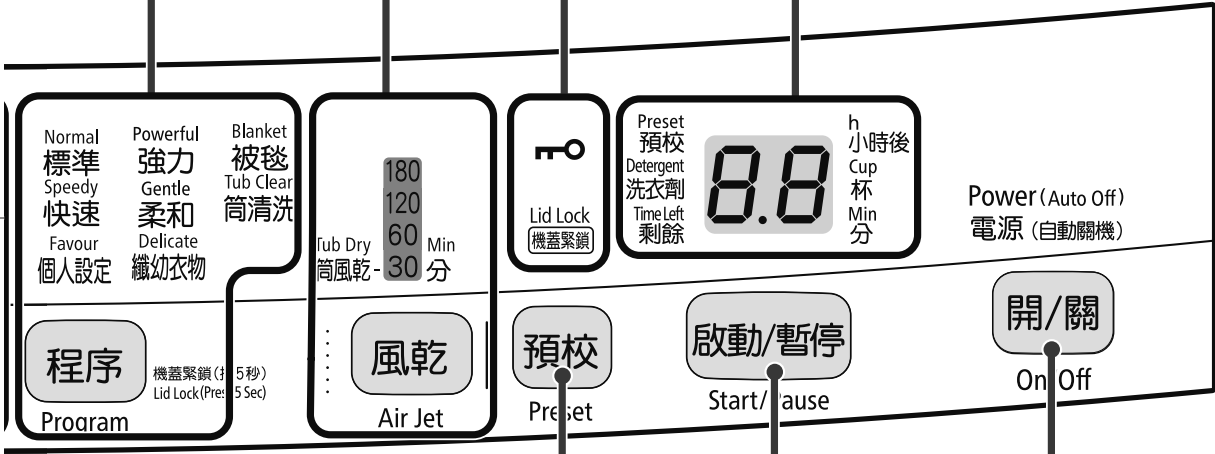

**Preset
預校
→(P.44)**

The duration of operation can be set to be anywhere between 3~24 hours (in units of 1 hour). 可將預定洗衣完成時間設定在 3~24 小時之間，以小時為單位。

**Start/Pause
啟動/暫停**

Start or pause. 啟動或暫停。

- If the machine is paused for over 1 hour, it will automatically power-off. 如果在暫停狀態下放置超過 1 小時，將自動切斷電源。

**Power
電源**

Turning the power on and off 開關電源。

- After operation is complete, the system will automatically power-off. 洗衣完成後，將自動切斷電源。
- If the machine is not started within 20 minutes after the power is turned on, the machine will automatically power-off. (Automatically powering-off) 如果接通電源後超過 20 分鐘未啟動，將自動切斷電源。(自動關閉電源)
- After turning off power, the machine will not respond to any button presses for about 5 minutes. power back on, please wait until the program lights are turned off before pressing the "power" button. 切斷電源後，約 5 秒鐘內無法操作按鈕。如需再次接通電源，請待程序指示燈熄燈後，按下「電源」按鈕。

洗衣 Wash change the sound notifications. 更改或關閉開始音，結束預告音，結束音。 →(P.46)

啟動/暫停 Start/Pause Turning off the pre-completion notification sound. 設定或解除結束預告音。 →(P.46)

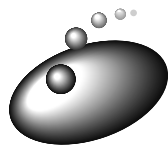

About the Lid Lock 關於機蓋緊鎖裝置

To ensure safety, when the automatic lid lock is set, the lid cannot be opened during operation
為安全起見，設定了自動機蓋緊鎖，在運轉結束前不會打開機蓋。

How to open the lid 打開機蓋方法

If you need to open the lid during operation, please press the "Pause" button. Once the lid lock is unlocked, you can open the lid.
如果要在運轉過程中打開機蓋，請按下「暫停」按鈕，待機蓋鎖解除後打開。
If you forcefully open it, you could damage the lid lock.
如果強行打開，可能導致機蓋鎖故障。

Opening the lid during operation 在運轉過程中打開機蓋

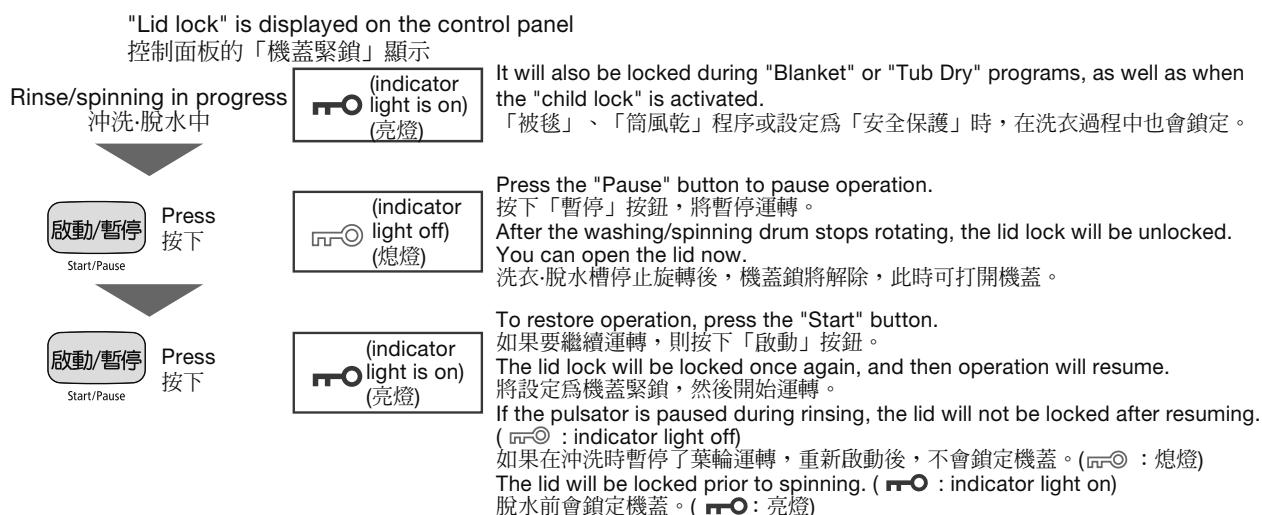

If power is cut off during operation, the lid will remain locked and operation will cease.
如果在運轉途中切斷電源，將繼續鎖定機蓋，然後結束運行。
Press the "Power" button to power up the machine. Wait about 5 seconds. Make sure that the lid lock indicator light is off before opening the lid.
按下「電源」按鈕接通電源，等待5秒鐘左右，確認機蓋緊鎖 顯示熄燈後，再打開機蓋。

Regarding the child lock 關於安全保護模式

You can lock the lid so that it cannot be opened to prevent children from opening the lid during operation or accidentally falling into the washing·spinning basket.
可強制鎖定機蓋，使機蓋無法打開，防止兒童在洗衣時打開機蓋或不慎落入洗衣·脫水槽中。

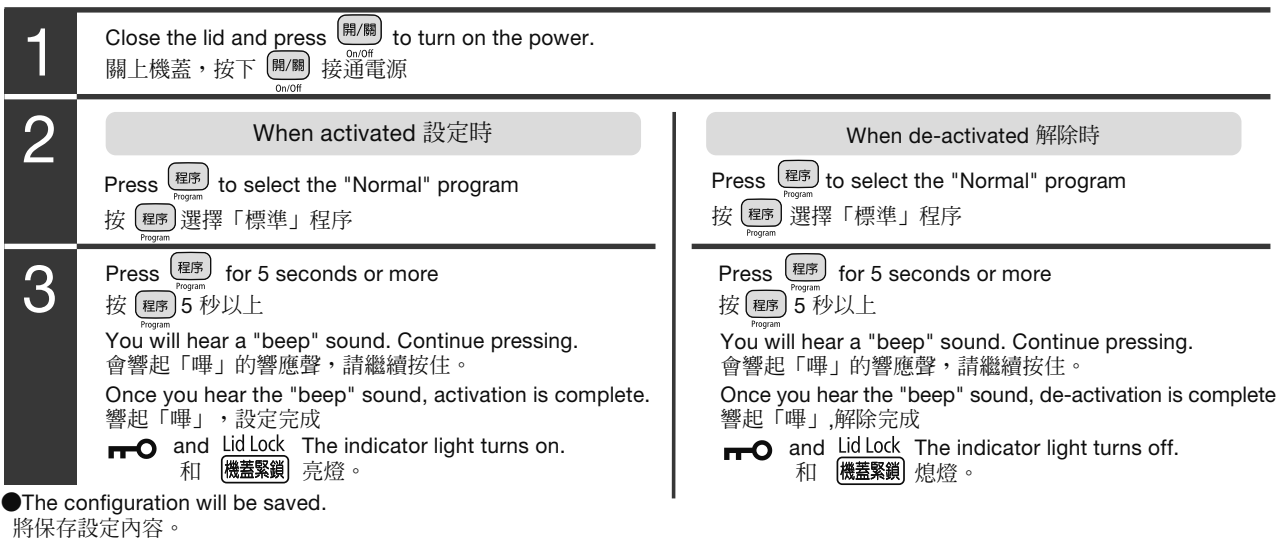

How to close the lid 關閉機蓋方法

Please hold onto the handle until fully closed.
請握住機蓋把手，完全關上。
If it is not fully closed, the lid lock will not be locked and operation cannot commence. This measure is put in place to ensure safety.
如果未完全關閉，將不會設定為機蓋緊鎖，因此無法開始運轉，以防發生危險。

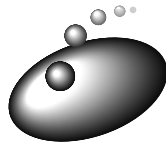





Preparing and checking clothes 準備和確認衣物

Please follow the instructions labeled on the garments as well as the notes and precautions.
請確認衣物上的使用指示和注意事項。

Clothes that cannot be washed or wind-dried 不可洗衣和風乾的衣物

The following clothes cannot be washed or wind-dried.
以下衣物不可清洗和風乾。

Otherwise, the clothes may shrink, deform, change color, become damaged, or deteriorate in quality.
否則可能導致衣物縮水、變形、變色、損傷或質地變差。

- Garments whose washing instructions include  or 
洗衣指示中有  或  的衣物
- Garments without usage instructions or garments without material composition labels
沒有使用指示或素材標籤的衣物
- Leather, fur, and down products, as well as products with decorations made from these materials
皮革、皮草、羽絨製品, 以及有這些裝飾品的製品
- Kimono as well as kimono accessories
和服、和服配件
- Ties, suits, and coats
領帶、西裝、大衣
- Artificial silk, cupro, as well as any mixture of the two
人造絲、銅氨纖維及其混紡品

- Silk products
絲綢製品
- Down products such as goose feathers
天鵝絨等絨毛製品
- Products with coatings, resins, or embossings
塗層加工、樹脂加工、壓花加工製品
- Blankets or carpets that are made 100% from fur or those with fur exceeding 10mm in length
100% 毛或絨毛超過 10mm 的毛毯或地毯
- Products that use strongly-twisted yarn, artificial fur products, or crepe products
使用強擰紗(大力捻轉過的紗)的毛紡品或縐紗製品

Otherwise, the garments will easily become unevenly distributed in the drum, resulting in abnormal vibrations, which would in turn cause machine malfunctions, injury to personnel, or damage to the machine.
否則衣物容易偏置, 引起異常振動, 導致洗衣機故障、用家受傷或洗衣機損壞。

- Waterproof products →(P.6)
Please do not wash (even if the garment have labels that say that they are washable).
防水產品 →(P.6)
即使衣物上有可洗標誌, 也勿洗衣。
- Doormats, rugs, and mats
門墊、地毯、墊子
 - Objects with rubber on the back side
背面有橡膠的物品
 - Objects that are thick and heavy
厚重的物品
 - Objects with long fur
長絨毛物品

- Rugs
地毯
- Seat cushions, pillows, back cushions
坐墊、枕頭、靠墊等
- Washing tools (washing balls, lint filters, etc)
洗衣輔助工具(洗衣球、棉絮過濾器)
- Objects with large amounts of hair from pets
附有大量寵物絨毛的物品

Clothes that cannot be wind-dried 不可風乾的衣物

The following types of clothes cannot be wind-dried.
以下衣物不可風乾。

Otherwise, shrinking, wrinkles, discoloring, damage, or deterioration of quality may result.
否則可能導致衣物縮水、褶皺、變色、損傷或質地變差。

- Rubber or polyurethane products
橡膠或聚氨酯製品
- Products such as furry toys that contain polyurethane(sponge materials)
含有聚氨酯(海綿類)的毛絨玩具等
- Cotton products such as quilts
被子等棉花製品
- Animal fur such as wool as well as products that contain such materials
羊毛等動物毛及其混紡品
- Lace or embroidery, as well as decorations or accessories that have them
有蕾絲或刺繡等裝飾或配件的製品
- Objects with dark colors printed on them
有深色印刷的物品

- Objects with the following usage instructions
有以下使用指示的物品

 Can be dry cleaned
可乾洗

 Leave to dry
晾乾

 Twist gently to dry
可輕輕絞乾

 Do not twist
不可扭絞

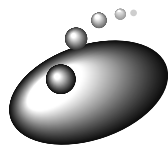

Professional washing 專業洗衣

Avoid unevenly distributing clothes in the tub 防止衣物偏置

When spinning to drain water, if clothes are unevenly distributed in the tub, the machine will automatically correct the situation, which will result in lengthening of the operation time.

脫水時如果衣物偏置，會自動修正偏置，因此運轉時間可能會變長。

In addition, this could result in excessive vibrations during spinning, causing the machine to stop prematurely.

此外，可能令脫水過程中振動過大，導致在運轉途中停止。

In order to prevent clothes from being unevenly distributed, please note the following.

要防止衣物偏置，請注意以下幾點。

When inserting clothes into the washing • spinning basket
將衣物放入洗衣-脫水槽時

- Place clothes evenly into washing • spinning basket and avoid clothes from being unevenly distributed on a single side.
- 將衣物均勻地放到洗衣-脫水槽中，防止重物偏向一側。
- Please do not insert too many clothes.
- 請勿塞入過多衣物。

When washing nets are used
使用洗衣網袋時

- Please do not insert too many clothes into the washing net
- 請勿在洗衣網袋中塞入過多衣物。
- Otherwise, the clothes may not be cleaned properly.
- 否則會洗不乾淨。
- Please zip up the washing nets.
- 請拉上洗衣網袋的拉鍊。
- Otherwise, the clothes could be damaged.
- 否則可能損傷衣物。
- Please do not use washing nets with lengths exceeding 40cm.
- 請勿使用邊長超過 40cm 的大型洗衣網袋。
- Otherwise, abnormal vibrations or uneven distribution of clothes may result.
- 否則可能導致異常振動或衣物偏置。

Large items (sheets or towels), thick items (jeans, judo clothing, coveralls, etc), as well as clothes inside washing nets
大件衣物(床單、毛巾)、較厚的衣物(牛仔褲、柔道服、連體服等)、洗衣網袋中的衣物

- Do not just wash a single piece of clothing.
- 不可單獨洗衣。
- At least 2 or 3 (or more) pieces of clothing should be washed together.
- 應 2、3 件一起洗，或與其他衣物一起洗。
- Please insert the clothes into the washing • spinning basket along with other pieces of clothing.
- 請先放入洗衣-脫水槽中，然後再放入其他衣物。









Reference weight of clothes 衣物參考重量

Reference values used to confirm the weight of clothes.

用於確認衣物重量的參考值。

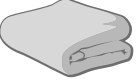
Please note that actual weights will vary based on the size and materials of the clothing.

實際重量因衣物的質料和大小不同而異，請注意。

	Underwear 貼身類	Shirts and pants 上衣、褲子類	Towels and sheets 毛巾、寢具類
50g	Briefs 內褲 	Socks 襪子 	
100g		Underwear 貼身衣物 	Towels 毛巾 
200g		Shirts 襯衫 	
300g			Bath towels 浴巾 
400g		Jeans 長褲  Skirts 裙子 	One-piece pajamas 連身睡衣 
500g			Sheets 床單 

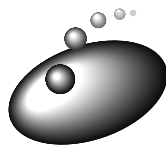

How to Use Liquid Detergent, Bleach and Fabric Softener 洗衣劑、漂白劑、柔順劑的使用方法

Please follow the proper steps and place the detergent and fabric softener into the feeding case.
請按照步驟，將適量的洗衣劑和柔順劑放入投入盒中。

Detecting the quantity of clothes you put in and displaying how much detergent you add in 檢測洗衣量與顯示洗衣劑量

Automatically detects the amount of clothes present and then displays the corresponding amount of detergent needed.
自動檢測洗衣量，然後顯示與之相應的洗衣劑量。

1 Place the clothes into the washing·spinning basket
將衣物放入洗衣·脫水槽

2 Turn on the power, select the program, and press
接通電源，選擇洗衣程序，按下

The pulsator and the washing·spinning basket begin to rotate, and the machine automatically detects the amount of clothes present.
葉輪和洗衣·脫水槽開始旋轉，自動檢測洗衣量。

If the water was added beforehand, or if the machine has been set to "Gentle", "Delicate", or "Blanket", the machine will not automatically detect the amount of clothes present.

如果已事先放好水，或設定了「柔和」、「纖幼衣物」、「被毯」程序，則不會自動檢測洗衣量。

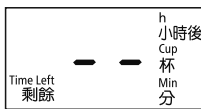

What is displayed when the amount of clothes is being detected
檢測衣物量時的顯示

Display the amount of detergent required (for reference) corresponding to the amount of clothes present.

顯示與洗衣量相應的洗衣劑量(參考)。

The "Gentle", "Delicate", or "Blanket" programs will display the required amounts of detergent based on the amount of water present.
「柔和」、「纖幼衣物」、「被毯」程序會根據水位顯示。

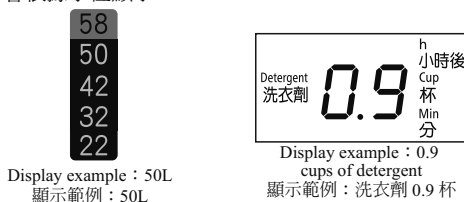

Display example : 50L
顯示範例：50L

Display example : 0.9 cups of detergent
顯示範例：洗衣劑 0.9 杯

Switch over to displaying time durations for the operations (reference).

切換為洗衣時間(參考)顯示。



Display example : 30 minutes
顯示範例：30 分

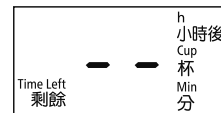

Display example : 100 minutes or more
顯示範例：100 分以上

3 Add detergent, liquid bleach and fabric softener according to the table on the right. Then, close the lid.
參考顯示，放入洗衣劑、液體漂白劑、柔順劑，關閉機蓋

How to add detergent, liquid bleach, and fabric softener→(P.20)

洗衣劑、液體漂白劑、柔順劑量的添加方法→(P.20)

Water cannot be added when the lid is open.

打開機蓋時，無法注水。

Water will begin to be added after the lid is closed.

關閉機蓋後，開始注水。

The amount of detergent and clothes and how to confirm the proper amount of detergent to be used. 洗衣劑及洗衣量及如何確認洗衣劑量

● If softeners with strong scents are used, the scents may be left over.

如果使用氣味較濃的柔順劑，可能會有氣味殘留。

● The amount of clothes will differ based on the types, size, and thickness of clothes.

洗衣量根據衣物的種類、大小、厚度不同而異。

During day-to-day washing activities, we recommend applying 70%~80% of the recommended clothing capacities.

在一般的清洗中，建議為參考洗衣量的 7~8 成。

● Before washing is completed, press to confirm the amount of detergent to be used(reference).If the machine is started with water already channeled in, the amount of detergent to be used will not be displayed (reference).

在洗衣結束前按 ，可以確認洗衣劑量(參考)。如果在已注水的狀態下啟動，不會顯示洗衣劑量(參考)。



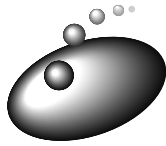

How to Use Liquid Detergent, Bleach and Fabric Softener (continued) 洗衣劑、漂白劑、柔順劑的使用方法（續）

How much Detergent·Liquid bleach·Fabric Softener to use 洗衣劑·液體漂白劑·柔順劑量

Please confirm how much detergent, liquid bleach, and fabric softener you should use by referencing the recommended (reference) detergent amount displayed on the control panel, and add the proper amounts into the machine.

請根據控制面板上顯示的洗衣劑量(參考)，確認洗衣劑、液體漂白劑、柔順劑的使用量，然後適量放入。

When stains are relatively light, you only need to use half of what you would usually need to use(50~60 percent).
較輕微的污漬可使用為正常的一半用量(5~6成)。

Model number 型號	Washing capacity 洗衣量	Water Level 水位 (Manual settings) (手動設定)	Synthetic detergent 合成洗衣劑		
			Concentrated detergent 濃縮型洗衣劑		Average detergent 一般洗衣劑
			20g is required for 30L of water Powder 水位 30L 需 20g 粉末	25ml is required for 30L of water Liquid 水位 30L 需 25ml 液體	40g is required for 30L of water or 40ml (powder and liquid) 水位 30L 需 40g或 40ml (粉末、液體)
BW-V80FSP/FS	Approximately 4.5~8kg 約4.5~8kg	50~58L	35~39g	35~39ml	70g(96ml)
	Approximately 4kg 約4kg	42L	31g	31ml	55g(75ml)
	Approximately 3kg 約3kg	32L	23g	23ml	41g(58ml)
	Approximately 1kg 約1kg	22L	16g	16ml	29g(40ml)

- How much detergent to use. For details, please refer to instructions provided by the detergent manufacturer. Please do not use powder detergents that produce a lot of bubbles.
洗衣劑的用量。詳細情況請參照洗衣劑生產廠家的說明。請勿使用多泡的洗衣粉。
- If your clothes are only lightly stained, the amount of detergent needed is only half of what is shown in the table above.
如果衣物只有輕微污漬，適合使用上表所顯示的一半洗衣劑量。
- Using too much detergent will not produce better cleaning results. To the contrary, using too much detergent will result in poor rinsing results and affect the quality of cleaning.
使用過多的洗衣劑並不能增強洗衣清潔效果，相反會因沖洗不充分而導致問題。
- The rated washing and spinning capacities for this machine are based on test cloths that conform with international standards. During actual usage, washing capacities may be different due to different clothing materials.
本機的定額洗衣、脫水容量，是以國家標準規定的實驗為準。實際使用時，因衣物質地不同，洗衣衣量會有所變化。

How to add detergent·liquid bleach·fabric softener 洗衣劑·液體漂白劑·柔順劑的添加方法

Insert the detergent and liquid bleach into the detergent feeding case, and insert the fabric softener into the fabric softener feeding case.
請將洗衣劑和液體漂白劑放入洗衣劑投入盒、將柔順劑放入柔順劑投入盒中。

Insert the detergent into the detergent feeding case and the fabric softener into fabric softener feeding case
洗衣劑投入盒、柔順劑投入盒

Detergent, liquid bleach, and fabric softener are inserted from different locations.
洗衣劑、液體漂白劑和柔順劑的投入口不同。

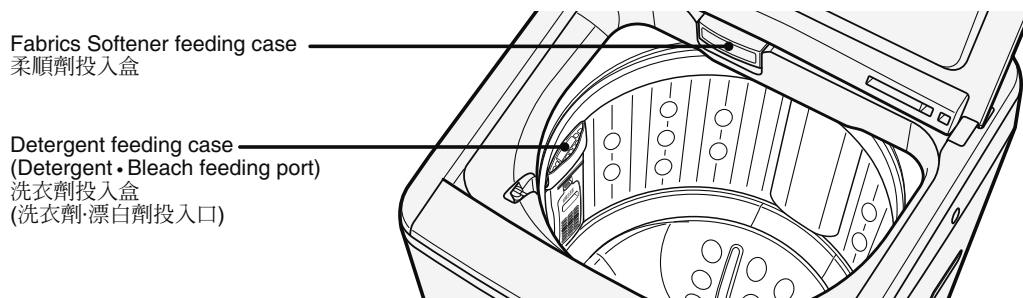







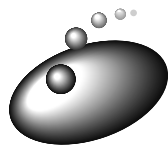





- When using natural soap powder or composite soaps, please do not place them into the detergent feeding case.
使用天然洗衣粉、複合肥皂時，請勿放入洗衣劑投入盒中。
- When the detergent feeding case or fabric softener feeding case require cleaning, please clean them using water.
Maintenance → (P.49、50)
洗衣劑投入盒、柔順劑投入盒髒污時，請用水清洗。保養方法 → (P.49、50)

Steps for adding detergent·liquid bleach·fabric softener
洗衣劑·液體漂白劑·柔順劑的添加步驟

1	<p>After reference amounts for detergents are displayed on the control panel, open the detergent feeding case 控制面板上顯示洗衣劑量(參考)後打開洗衣劑投入盒</p>
2	<p>Insert the detergent into the feeding port Please insert the proper amount of detergent in accordance with displayed instructions. →(P.20) 將洗衣劑放入投入口 請按照顯示的洗衣劑量放入。→(P.20)</p> <ul style="list-style-type: none"> ● Too much detergent being added could result in malfunction or leakage of water. 如果放入過量的洗衣劑，可能導致故障或漏水。 ● Do not insert detergent into the fabric softener feeding case. 請勿將洗衣劑放入柔順劑投入盒中。 Otherwise, malfunctioning could occur. 否則可能導致故障。 ● If detergent forms blocks, please crush the blocks before inserting. 如果洗衣劑結塊，請搗碎後再放入。 There may be detergent residue in the detergent feeding case. 洗衣劑投入盒中可能殘留洗衣劑。 ● In order to reduce the amount of high-viscosity detergent liquid residue, please dilute with water before inserting. 爲了減少高黏度液體洗衣劑的殘留，請用水稀釋後放入投入口中。 ● If tablet-shaped, thin tablet shaped, or block-shaped detergent is used, please place it directly in the washing · spinning basket after it has been fully dissolved. 使用藥丸型、薄片型、方塊型洗衣劑時，請在充分溶解後直接放入洗衣·脫水槽中。 ● Please place gel-ball detergents directly into the washing · spinning basket. 凝膠球等洗衣劑請直接放入洗衣·脫水槽中。 ● Please do not insert detergent into the detergent feeding case without washing. 請勿在洗衣劑投入盒中放入洗衣劑後長時間放置。 This may cause the detergent to agglomerate, which would in turn result in leakages when inserting water. 可能造成洗衣劑凝結，導致注水時漏水。
3	<p>(when necessary) Insert liquid detergent into the feeding port (需要時) 將液體漂白劑放入投入口</p> <ul style="list-style-type: none"> ● Please follow instructions regarding how much bleach should be used as well as how to use the bleach 使用量及使用方法請遵守漂白劑的指示說明。 ● Do not directly apply liquid bleach to garments. 請勿將液體漂白劑直接灑在衣物上。 Otherwise, the color of garments could be lost and holes in the garments could result. 否則可能導致衣物變色、破洞。 ● Please do not insert bleach that contains chlorine into the washing · spinning basket without washing. 請勿在洗衣·脫水槽中放入含氯漂白劑後長時間放置。
4	<p>Close the detergent feeding case 關上洗衣劑投入盒 Please fully close the detergent feeding case. 請完全關上洗衣劑投入盒。 (If it is open, clothes may be damaged or the detergent feeding case may be damaged) (如果打開，可能損傷衣物或損壞洗衣劑投入盒)</p>
5	<p>(Pull out the fabric softener feeding case if necessary) Insert the fabric softener into the feeding port (需要時拉出柔順劑投入盒) 將柔順劑放入投入口</p> <ul style="list-style-type: none"> ● Please do not insert too much fabric softener. (No more than 60mL should be inserted) 請勿放入過多的柔順劑。(最多不得超過 60mL) If it leaks out, it may result in decoloring or blackening of clothes. 流出後會直接沾到衣物上，可能造成變色、發黑。 ● Please do not place for too long after inserting fabric softener. 請勿在放入柔順劑後長時間放置。 Otherwise, the fabric softener may agglomerate. 否則柔順劑可能結塊。 ● After washing, it is normal for a small amount of water to be left over. 洗衣結束後會殘留少量水，屬正常現象。 ● The following types of detergent and fabric softener may leave a scent. 以下洗衣劑和柔順劑可能有氣味殘留。 <ul style="list-style-type: none"> • Fabric softeners with strong scents 香味較濃的柔順劑 • Products that are stickier 黏度高的產品 <p>Please try the following methods. 請嘗試以下方法。</p> <ul style="list-style-type: none"> • Use a smaller amount of detergent or fabric softener. 減少洗衣劑或柔順劑的用量。 • Use a fabric softener with a lighter scent. 試試香味不太濃的柔順劑。 • Use the "Tub Clean" program to wash the washing · spinning basket.→(P.51) 用「筒清洗」程序沖洗洗衣·脫水槽。→(P.51)
6	<p>Close the fabric softener feeding case 關上柔順劑投入盒 Please fully close the fabric softener feeding case. 請完全關上柔順劑投入盒。 If you forcefully close it, the fabric softener feeding case could be damaged. 如果強行關閉，可能損壞柔順劑投入盒。</p>



How to select programs 洗衣程序的選擇方法



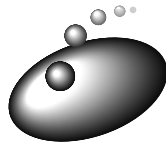

Program 程序	Types of items to be washed 洗衣物種類	Operation method (Maximum washing and wind-dry capacities) 洗衣方法(最大洗衣·脫水風乾容量)			Recommended detergents→(P.20) (with the exception of Air Jet • Tub Dry program) 推薦洗衣劑→(P.20) (風乾、筒風乾程序除外)	
		Washing 洗衣	Washing and wind-drying 洗衣·脫水風乾	Spinning and wind-drying 脫水風乾		
Normal 標準	Ordinary clothing 普通衣物 ·Pajamas 睡衣 ·Underwear, etc. 貼身衣物等		8kg	—	—	Synthetic powder detergent 粉末合成洗衣劑 Synthetic liquid detergent 液體合成洗衣劑
Speedy 快速	When you wish to quickly wash clothes with relatively light stains 希望快速清洗較輕微污漬的衣物時 ·Pajamas 睡衣 ·Underwear, etc. 貼身衣物等		3.5kg	—	—	Speedy program 快速程序 Special detergent 專用洗衣劑
Powerful 強力	Clothes with heavy stains or thicker clothes 污漬較多或者較厚的衣物 ·sportwear運動服 ·socks襪子		8kg	—	—	Synthetic powder detergent 粉末合成洗衣劑 Synthetic liquid detergent 液體合成洗衣劑
Favour 個人設定	When you want to design your own program 希望自己設計程序時 ·Ordinary clothes 普通衣物		8kg	—	—	Synthetic powder detergent 粉末合成洗衣劑 Synthetic liquid detergent 液體合成洗衣劑
Gentle 柔和	Need to wash gently, such as underwear 貼身衣物等需注意衣物 ·Underwear 貼身衣物 ·Stocking, etc. 絲襪等		3kg	—	—	Neutral liquid detergent or Synthetic liquid detergent 中性液體洗衣劑或液體合成 洗衣劑
Delicate 纖幼衣物	Clothes that are labeled Air Jet 帶風乾標誌的衣物 ·Skirts 裙子 ·Sweaters, etc. 毛衣等		1.2kg	—	—	Detergent for use with clothes that are labeled dry-clean 乾洗標誌衣物專用洗衣劑 Neutral liquid detergent 中性液體洗衣劑
Blanket 被毯	Blanket, quilts, etc. 毛毯、被子等 ·Acrylic blankets 腈綸毛毯 ·Quilts·mattress covers, etc. 被子·褥子等		Blankets:4.2kg 毛毯：4.2kg Quilts:1.8kg 被子：1.8kg	—	—	Synthetic powder detergent 粉末合成洗衣劑 Synthetic liquid detergent 液體合成洗衣劑
Tub Clean 筒清洗	When the washing·spinning basket is extremely dirty or has strong odors 洗衣·脫水槽明顯髒污或有臭味時使用 ·Please do not insert clothes. 請勿放入衣物。		11 hours 11 小時 3 hours 3 小時	—	—	Commercial washing machine tub cleaners 市面上的洗衣機筒清潔劑 Chlorine-based bleach for clothing 衣物用氯漂白劑
Air Jet 風乾	When you want to just leave clothes that cannot withstand heat (synthetic fibers) or only comprise of a small amount 希望風乾少量衣物或非耐熱材質(化學纖維)的衣物時 ·Underwear, etc. 內衣等		—	—	Synthetic fiber: 2kg 化學纖維：2kg	—
Tub Dry 筒風乾	Prevents mold from forming in the washing·spinning basket 防止洗衣·脫水槽發霉 ·Please do not insert clothes. 請勿放入衣物。		—	—	30 minutes 30分	—
Soak for 120 minutes 浸洗 120 分	When you want to prevent clothes from turning yellow 希望防止變黃時使用		3.5kg	—	—	Synthetic powder detergent 粉末合成洗衣劑 Synthetic liquid detergent 液體合成洗衣劑
Soak for 360 minutes 浸洗 360 分	When you wish to remove stubborn stains for yellow patches 希望去除頑固污漬或黃斑時		2kg	—	—	Synthetic powder detergent 粉末合成洗衣劑



Select Detergent 選擇洗衣劑

Programs that can be configured 可設定的程序

"Normal", "Powerful", "Favour", "Soak for 120 minutes".
「標準」、「強力」、「個人設定」、「浸泡120分」。







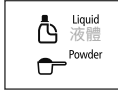
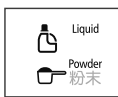
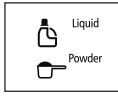



Setting 程序	Display board 面板顯示	Running content 運作內容
Powder 粉末	 	<p>Wash after fully dissolving the powder detergent. 將粉末洗衣劑充分溶解後再進行洗衣。</p> <p>Automatically set at the factory. 機器出廠時的原廠設定。</p>
Liquid 液體	 	<p>Increase the number of rotations of the pulsator to fully agitate the laundry, and use a program suitable for liquid detergent to wash. 增加波輪轉動次數使洗滌物被充分攪動，使用適合液體洗衣劑的程序進行洗衣。</p> <p>The rinsing times will be change to 1 time. 沖洗次數變為1次。</p> <p>Rinsing times can be change. 沖洗次數可進行更改→(P.37)</p>

Programs that can not be configured 無法設定的程序

"Speedy", "Gentle", "Delicate", "Blanket", "Tub Clean", "Soak for 360 minutes".
「快速」、「柔和」、「織幼衣物」、「被毯」、「筒清洗」、「浸泡360分」。

Setting 程序	Display board 面板顯示	Running content 運作內容
Speedy, Gentle 快速、柔和 Delicate, Blanket 織幼衣物、被毯		<p>Automatically set to use liquid detergent. 自動被設定為使用液體洗衣劑。</p> <p>Please do not use powder detergent, it may dissolve incompletely. 請不要使用粉末洗衣劑，可能會溶解不完全。</p> <p>Please refer to the recommended laundry detergent. 請參考推薦洗衣劑。→ (P.22)</p>
Soak for 360 minutes 浸泡360分		<p>Automatically set to use liquid detergent. 自動被設定為使用液體洗衣劑。</p> <p>Use powder detergent to clean the macula, dirt, etc. 為了洗淨黃斑黴污等請使用粉末洗衣劑。</p>
Tub clean 筒清洗		<p>Please do not use laundry detergent. 無需使用洗衣劑，無法設定。</p> <p>Please refer to the recommended laundry detergent 請參考推薦洗衣劑。→ (P.22)</p>

Usage method 使用方法

Preparations 準備	Turn on the water and insert clothes. 打開水龍頭，放入衣物。		
1	Press  to turn on the power. 按下  ，接通電源。		4 Press  will automatically measure the amount of laundry and display the water level and the amount of detergent (standard) that should be used at that amount. When water has been pre-filled in the washing / spinning basket, the amount of laundry cannot be measured. 按下  會自動測量洗衣量，並顯示出在該重量下應使用的水量及洗劑量(標準)。當洗衣/脫水槽內已預先注水時，將無法測量洗衣量。
2	Press  or  to select a program. 按下  或  ，選擇程序。 A different program is selected each time it is pressed. 每按一次更改所選程序。		5 Add the recommended amount (reference only) of detergent, bleach, and fabric softener, and then close the lid→ (P.19-21) 按照洗衣劑量(參考)放入洗衣劑、漂白劑和柔順劑後關閉機蓋→ (P.19-21)
3	Press  and select powder detergent or liquid detergent. 按下  ，選擇粉末洗衣劑或液體洗衣劑。		6 After washing is complete, remove the clothes and clean the lint filter → (P.48) 完成洗衣後，取出衣物，清潔棉絮過濾器→ (P.48)

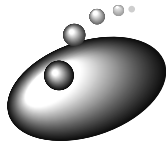

Washing 洗衣

Steps for washing. You can select a program you like.
洗衣時的步驟。可選擇您喜歡的程序。

Usage method 使用方法

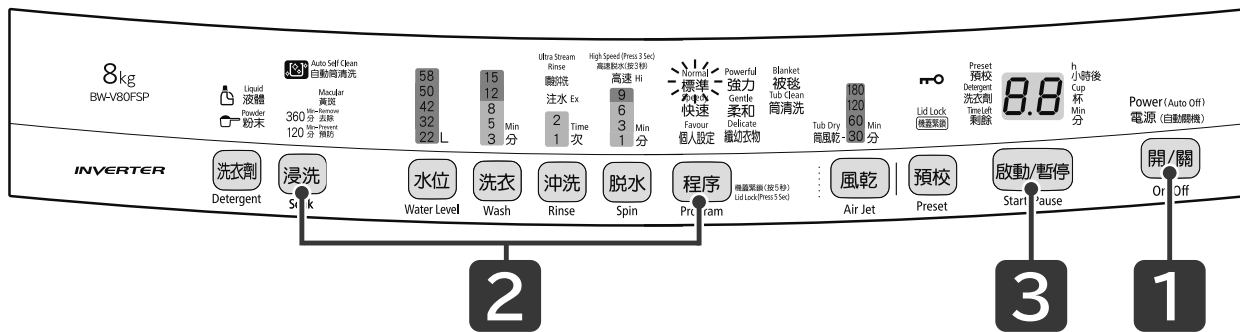

Preparations 準備

Turn on the water and insert clothes → (P.17、18)
打開水龍頭，放入衣物 → (P.17、18)

1

Press to turn on the power

按下 ，接通電源

2

Press or to select a program

按 或 選擇程序

A different program is selected each time it is pressed.
每按一次更改所選的程序。

3

Press

按下

The machine will automatically detect the amount of clothes present and then display the amount of water and detergent required (reference only). → (P.20)

將自動檢測洗衣量，然後顯示水位和洗衣劑量(參考)。→ (P.20)

If water has already been added to the washing • spinning basket, or if the machine has been set to "Gentle", "Delicate", "Blanket" the machine will not perform automatic detection.

如果已事先在洗衣 • 脫水槽中放好水，或設定了「柔和」、「纖幼衣物」、「被後」程序，則不會檢測。

4

Add the recommended amount (reference only) of detergent, bleach, and fabric softener, and then close the lid → (P.19~21)

按照洗衣劑量(參考)

放入洗衣劑、漂白劑和柔順劑後關閉機蓋 → (P.19~21)

5

After washing is complete, remove the clothes and clean the lint filter → (P.48)

完成洗衣後，取出衣物，

清潔棉絮過濾器 → (P.48)

⚠ Note 注意

This is to prevent the machine from abnormally vibrating during spinning and resulting in malfunctioning of the machine or injury of personnel, etc. → (P.6)
為防止脫水時異常振動導致用家受傷、故障等 → (P.6)

- Hard items such as waterproof mats, thin covers, clothes, rugs, door mats etc., or products made from synthetic fibers that do not easily absorb water cannot be washed, rinsed, spun, or air jet spun.
不可清洗、沖洗、脫水和風乾防水的墊子、薄膜、衣物、擦腳墊、門墊等硬物，或很難進水的纖維製品、地毯。
 - Please do not fold large items such as blankets for washing.
請勿將毛毯等大件物品折疊起來清洗。
 - Please do not use large washing nets with side longer than 40cm.
請勿使用邊長超過 40cm 的大型洗衣網袋。
- Otherwise, abnormal vibrations during washing may cause items being washed to fly out, result in damage to clothes, or damage to the washing machine, surrounding walls, or the floor.
否則可能因脫水時的異常振動，導致洗衣物飛出、損傷衣物、造成洗衣機或周圍牆壁、地板損壞。

Detailed settings 詳細設定

After you select a program, you can modify its details as well as add or remove certain settings.

選擇程序後，可更改行程，或設定和解除各功能。

Configure the settings according to your preferences.

請根據您的喜好設定。

(Some programs may not be modified or configured)

(有些程序中可能無法更改或設定)

Program 行程	Select Detergent 選擇洗衣劑 →(P.23)	Ultra-Stream Rinse 噴射沖洗 →(P.43)	Rinse 沖洗 →(P.43)	Auto Self Clean 自動筒清洗 →(P.42)	High Speed Spin 高速脫水 →(P.47)	Preset 預校 →(P.44)	Rotation, water insertion and rinsing 旋轉噴淋沖洗 →(P.47)
Normal 標準	<input type="radio"/>	<input type="radio"/>	<input type="radio"/>	<input type="radio"/>	<input type="radio"/>	<input type="radio"/>	<input type="radio"/>
Speedy 快速	—	—	<input type="radio"/>	<input type="radio"/>	<input type="radio"/>	<input type="radio"/>	<input type="radio"/>
Favour 個人設定	<input type="radio"/>	<input type="radio"/>	<input type="radio"/>	<input type="radio"/>	<input type="radio"/>	<input type="radio"/>	<input type="radio"/>
Powerful 強力	<input type="radio"/>	<input type="radio"/>	<input type="radio"/>	<input type="radio"/>	<input type="radio"/>	<input type="radio"/>	<input type="radio"/>
Gentle 柔和	—	—	<input type="radio"/>	—	—	—	<input type="radio"/>
Delicate 織幼衣物	—	—	<input type="radio"/>	—	—	—	<input type="radio"/>
Blanket 被毯	—	—	—	—	<input type="radio"/>	<input type="radio"/>	—
Soak for 120 minutes 浸洗 120分	<input type="radio"/>	<input type="radio"/>	<input type="radio"/>	<input type="radio"/>	<input type="radio"/>	<input type="radio"/>	<input type="radio"/>
Soak for 360 minutes 浸洗 360分	—	<input type="radio"/>	<input type="radio"/>	<input type="radio"/>	<input type="radio"/>	<input type="radio"/>	<input type="radio"/>

○ … 可設定 — … 無法設定

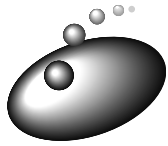

Air Jet Program 風乾程序

When you wish to spin and wind-dry a small amount of clothes after washing is complete, or when you want to wind-dry clothes made of materials that cannot withstand heat (synthetic fibers).
完成洗衣後，希望脫水風乾少量衣物或非耐熱材質(化學纖維)的衣物時。

Usage method 使用方法

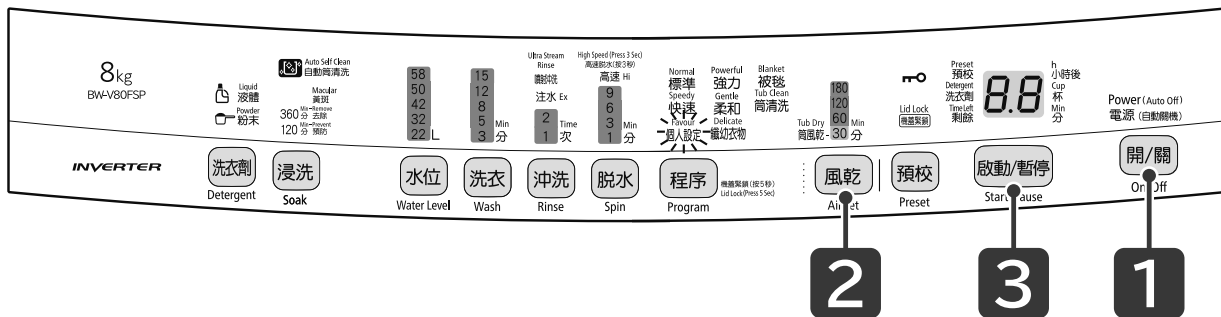

Preparations 準備

Open up each garment and put them in one by one → (P.17、18)
打開每一件衣物，一件一件放入 → (P.17、18)

1

Press to turn on the power
按下 ，接通電源

2

Press and select a time duration
按下 ，選擇時間

3

Press
按下

4



After washing is complete, remove the clothes
and clean the lint filter → (P.48)
完成風乾後，取出衣物，
清潔棉絮過濾器 → (P.48)

⚠ Note 注意

This is to prevent the machine from abnormally vibrating during spinning and resulting in malfunctioning of the machine or injury of personnel, etc. → (P.6)
為防止脫水時異常振動導致用家受傷、故障等 → (P.6)

- Hard items such as waterproof mats, thin covers, clothes, rugs, door mats etc., or products made from synthetic fibers that do not easily absorb water cannot be washed, rinsed, spun, or air jet spun.
不可清洗、沖洗、脫水和風乾防水的墊子、薄膜、衣物、擦腳墊、門墊等硬物，或很難進水的纖維製品、地毯。
 - Please do not fold large items such as blankets for washing.
請勿將毛毯等大件物品折疊起來清洗。
 - Please do not use large washing nets with side longer than 40cm.
請勿使用邊長超過 40cm 的大型洗衣網袋。
- Otherwise, abnormal vibrations during washing may cause items being washed to fly out, result in damage to clothes, or damage to the washing machine, surrounding walls, or the floor.
否則可能因脫水時的異常振動，導致洗衣物飛出、損傷衣物、造成洗衣機或周圍牆壁、地板損壞。

Detailed settings 詳細設定

Press  to switch between settings.
每次按下  即可切換設定。



Program 程序	Maximum washing capacity 最大洗衣容量	Time duration 洗衣時間
Air Jet 風乾	Synthetic fiber: 2kg 化學纖維: 2kg	30 minutes 30 分
		60 minutes 60 分
		120 minutes 120 分
		180 minutes 180 分

Recommended quantity of clothes 參考洗衣量

Recommended quantity of clothes to put into the washing • spinning basket (reference only).
將衣物放入洗衣 • 脫水槽時的參考量。

The reference quantity refers to the state of clothes after they have gone through spinning and remain wet.
參考量為脫水後濕衣物展開放入的狀態。

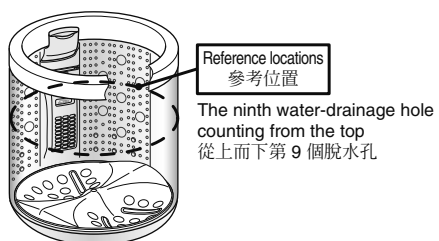

Please do not exceed the reference position.
請勿超過參考位置。
Otherwise, this may lead to damage of clothes, uneven
wind-drying and wrinkles.
否則可能損傷衣物，或導致風乾不均和皺紋。

■ Drying is not performed with a heater. 不是用加熱器風乾。

The level of dryness may differ depending on the quantity of clothes present, the types of clothes present, the temperature, the humidity, the state of ventilation in the room, as well as the overall environment.

根據洗衣量、類型、氣溫、濕度、室內的氣流狀態、安裝環境不同，乾燥程度也不同。

Since this is a simple drying mode that has a fixed time duration, please run again if the clothes are not sufficiently dry.
由於是定時式簡易風乾，因此如果乾燥不足，請繼續運行。

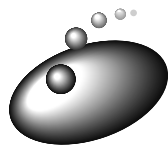

Favour Program (design your own program) 個人設定程序 (自己設計程序)

Program the washing machine to use your preferred water levels, washing settings, rinse settings, and spin settings, etc.
可根據您的喜好設定水位、洗衣、沖洗、脫水等，然後輸入到洗衣機。
You can save frequently used settings as "Favour" programs for use later.
可將常用的洗衣內容輸入到「個人設定」程序中，方便使用。
(Programs other than "Favour" programs can also be changed, but cannot be saved)
(也可更改並運行「個人設定」以外的程序內容，但不能儲存)

Usage method 使用方法

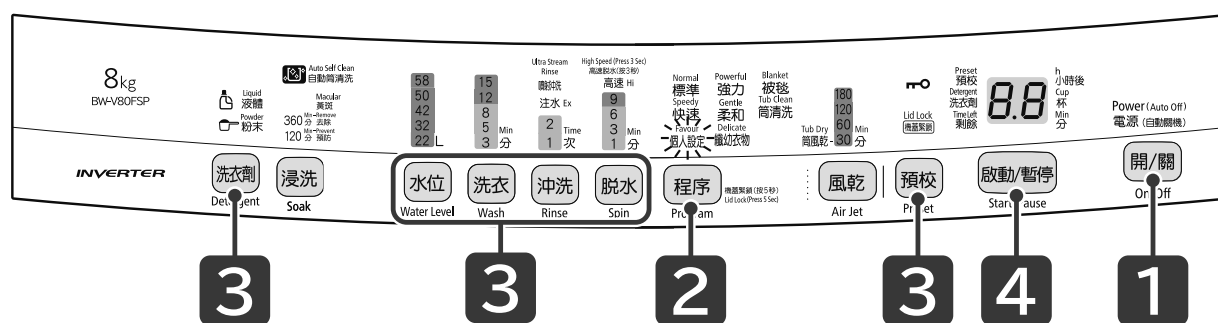

Preparations 準備

Turn on the water and insert clothes → (P.17、18)
打開水龍頭，放入衣物 → (P.17、18)

1

Press **開/關** to turn on the power
按下 **開/關**，接通電源

2

Press **程序** and select the "Favour" program
按 **程序** 選擇「個人設定」程序

3

Press **水位** **洗衣** **沖洗** **脫水** **預校** **洗衣劑** any of the buttons, and configure the operation settings
任意按下 **水位** **洗衣** **沖洗** **脫水** **預校** **洗衣劑** 中的按鈕，設定行程內容

4

Press **啟動/暫停**
按下 **啟動/暫停**
Press the start button to save the settings.
按下開始按鈕後，將儲存設定。

5

Add the recommended amount (reference only) of detergent, bleach, and fabric softener, and then close the lid → (P.19~21)
按照洗衣劑量 (參考) 放入洗衣劑、漂白劑和柔順劑後關閉機蓋 → (P.19~21)

6

After washing is complete, remove the clothes and clean the lint filter → (P.48)
完成洗衣後，取出衣物，清潔棉絮過濾器 → (P.48)

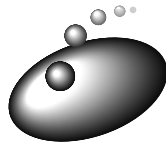

Blanket program 被毯程序

Programs for cleaning large objects such as blankets and large garments.

清洗被毯等大件衣物的程序。

The pulsator does not rotate, but cleans clothes without damaging them using the water flow produced by the washing • spinning basket. 葉輪不旋轉，利用洗衣 • 脫水槽轉動產生的旋轉水流，清洗衣物之餘，同時不傷衣物。

● Please do not use programs other than the "Blanket" program to wash blankets, quilts, mattress covers, or curtains.

Otherwise, the blankets may be damaged.

清洗毛毯、被子、褥子、窗簾時，除了「被毯」程序之外，請勿使用其他程序。

否則可能造成被毯等損傷。

● Please do not fold large objects when cleaning.

請勿將大件物品摺疊起來清洗。

Otherwise, objects such as blankets could form shapes that cause imbalances during spinning, thereby resulting in abnormal vibrations.

否則被毯等衣物可能糾結在一起，導致脫水時不平衡，引起異常振動。

Please place blankets and quilts in accordance with the methods described on. →(P.31)

請按照毛毯、被子的疊法和放法。→(P.31)

● The "Blanket" program does not automatically detect the amount of cloths.



「被毯」程序中不會自動檢測衣物量。



Preparations

洗前準備

Washable clothes

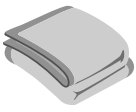
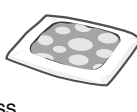
可洗衣物

	Blankets 毛毯	Quilts 被子
Materials 質料	Acrylic or polyester fibers 腈綸或聚酯纖維	The filler material is 100% polyester fiber 填充物材質為 100% 聚酯纖維
Graphical label used 使用圖形標誌	手洗 (hand wash gently) labels  (輕柔手洗) 標誌	When the filler is down 填充物為羽絨時  (machine washable with some machines) or (有些洗衣機可洗) 或 手洗 (hand wash gently) labels  (輕柔手洗) 標誌
Dimensions 尺寸	width 180cm X length 230cm (double) or less with a weight of 4.2kg or less (each) 寬 180cm×長 230cm (雙人) 或以下 一張重量 4.2kg 或以下 	Quilts (single) width 150cm X length 210cm or less 被子(單人) 寬 150cm×長 210cm 或以下 Thin quilts (double) width 190cm X length 210cm or less filling materials should weigh 1.8kg or less 薄被(雙人) 寬 190cm×長 210cm 或以下 填充物重量 1.8kg 或以下 
Clothes than cannot be washed 不可洗衣的衣物	● Wool or cashmere 羊毛或羊絨 ● Electric heating blankets" 電熱毯 Please wash washable electric heating blankets according to the instructions in their instruction manuals. 可洗的電熱毯請按照電熱毯的使用說明書清洗。	● Filler material is wool 填充物為羊毛 ● Quilt cover material is silk 被套質料為絲質

In addition, mattress covers and curtains (4.2kg or less) with  (hand wash gently) labels can also be washed.
此外，有  (輕柔手洗) 標誌的被褥和窗簾(4.2kg或以下)也可洗衣。

Detergent used

使用的洗衣劑

Synthetic liquid detergents

液體合成洗衣劑

Please only use liquid detergents. Powder detergents may not fully dissolve.

請勿使用液體洗衣劑以外的洗衣劑。粉末洗衣劑可能會無法完全融化。

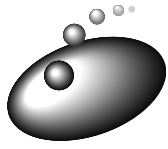

Blanket program 被毯程序 (續)

How to use the washing cap 洗衣蓋的使用方法

A washing cap that is sold separately is needed to prevent clothes from flying out during operation. →(P.60)

需要另售的洗衣蓋，防止衣物在運轉過程中飛出。→(P.60)

If the washing machine is used without a washing cap, clothes as well as the washing machine may be damaged.

不用洗衣蓋洗衣時，可能會造成衣物損傷及洗衣機損壞。

These damages are not covered by the warranty.

此類情況不在保養範圍內。

(The user will be responsible for any damaged clothes and a fee will be charged for repair services)

(衣服損壞費用由用戶承擔，維修亦需另行收費)

Blanket 毛毯				Delicate 纖幼衣物	
Blankets 毛毯		Quilts 被子		Operational capacity 洗衣容量	washing cap 洗衣蓋
Operational capacity 洗衣容量	washing cap 洗衣蓋	Operational capacity 洗衣容量	washing cap 洗衣蓋		
2.2kg or less 2.2kg或以下	Not required 不需要	1.8kg or less 1.8kg或以下	Required 需要	0.4kg or less 0.4kg或以下	Not required 不需要
2.2kg~4.2kg	Required 需要			0.4kg ~1.2kg	Required 需要

Installation of the washing cap 洗衣蓋的安裝方法

- Bend the washing cap and align the concave portion with the convex portion (plastic) of the washing · spinning basket
將洗衣蓋彎曲，凹位嵌入洗衣·脫水槽的凸位(塑料)並對齊
washing cap
洗衣蓋

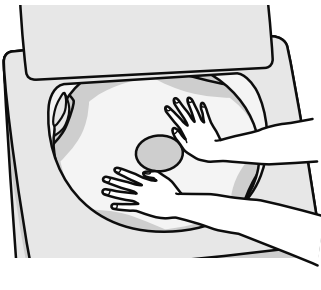

- As shown in the figure, place the entire washing cap into the washing · spinning basket
如圖所示，將整個洗衣蓋放入洗衣·脫水槽中

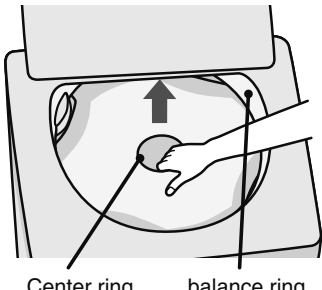

- Hold the center ring and pull it so that it is located under the balance ring
抓住中圈，拉到平衡環下
Center ring
中圈
balance ring
平衡環

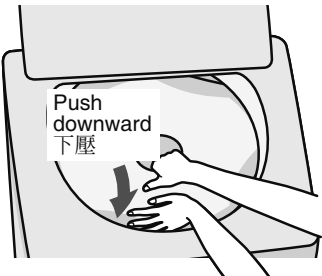

How to remove the washing cap 洗衣蓋的拆卸方法

- Push down the washing cap close to you
下壓靠近身體的洗衣蓋
Push downward
下壓

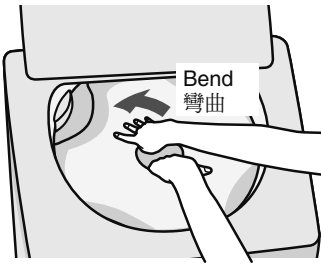
- As shown in the figure, hold onto the center ring and bend it in the direction of the arrow
如圖所示抓住中圈，向箭頭方向彎曲
Bend
彎曲

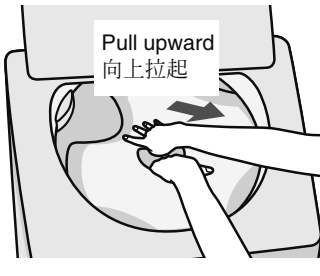

- Then, pull it upward
然後向上拉起
Pull upward
向上拉起



When installing and removing, please make sure that the washing cap does not come into contact with the lint filter.
請注意安裝和拆卸時，洗衣蓋不可碰到棉絮過濾器。
Otherwise, the lint filter may be damaged or fall off.
否則可能導致棉絮過濾器脫落或損壞。

How to fold and place blankets as well as quilts 毛毯、被子的疊法和放法

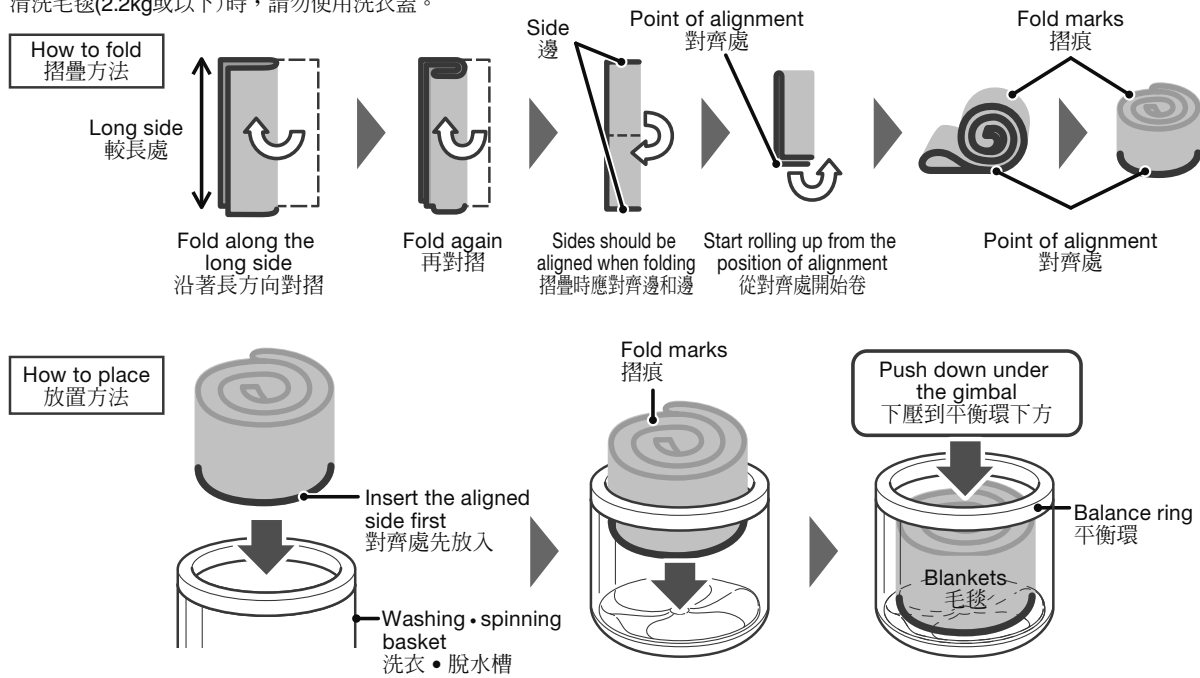
When washing blankets (2.2kg or less), please do not use the washing cap.
清洗毛毯(2.2kg或以下)時，請勿使用洗衣蓋。



If the aligned side of blankets are not inserted into the washing • spinning basket first, blankets may be damaged during operation.
如果不將毛毯的對齊處先放入洗衣 • 脫水槽，在運轉時可能會損壞毛毯。

How to dry blankets and quilts 毛毯、被子的晾乾方法

Dry naturally in a well-ventilated location. (In the case of a quilt, it will take about 4 hours to dry on a sunny day)
在通風良好的地方自然風乾。(如果是被子，晴天約需 4 小時)

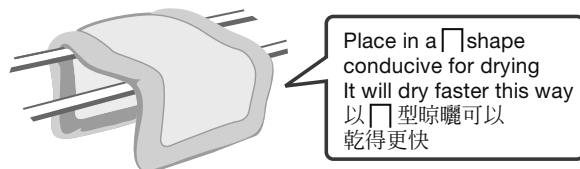

- Blanket
毛毯 : When the blanket is still wet, use a brush to brush the fabric in a single direction so that it will continue to look good.
趁毛毯潮濕時，使用刷子將毛朝同一方向梳理整齊，使之保持美觀。
- Quilt
被子 : When leaving mattress covers to dry, turning it over frequently will allow it to dry even faster.
晾曬被褥時，若能經常將其翻轉，會更快晾乾。
When leaving it to dry, if you tap on it frequently, it will become fluffier and more comfortable.
晾曬時，若能經常拍打被褥，會使棉被蓬鬆舒適。
- Down quilt
羽絨被 : Straightening down filling that has become skewed will allow the quilt to dry as well as become fluffier and more comfortable.
整理羽絨被中偏斜了的羽絨，可使棉被容易晾乾並蓬鬆舒適。
To prevent down materials from deteriorating or being damaged, please use cover sheets to protect quilts.
為防止羽絨變質或被褥受損，請蓋上被單以保護被子。

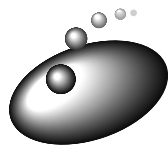

Blanket program 被毯程序 (續)

Usage method 使用方法

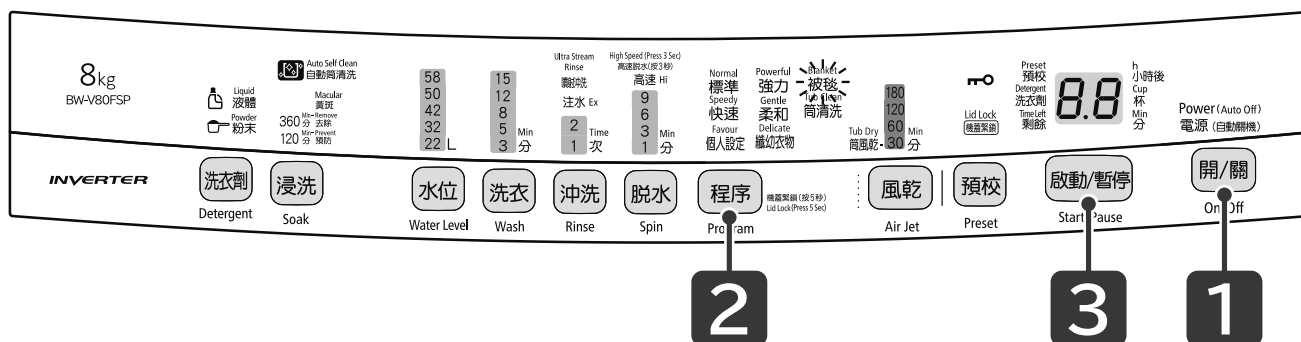

Preparations 準備

Turn on the water faucet and add clothes →(P.29)
打開水龍頭，放入衣物 →(P.29)

Acceptable capacities when washing cap are used →(P.30)
使用洗衣蓋時可洗衣的容量 →(P.30)

1

Press to turn on the power
按下 ，接通電源

2

Press and select the "Blanket" program
按 選擇「被毯」程序
The water level will be automatically set to "58L."
Detailed settings →(P.37)
水位將自動設為「58L」。
詳細設定 →(P.37)

3

Press
按下

4

Add liquid detergent and fabric softener, and then close the lid →(P.19~21)
放入液體洗衣劑、柔順劑後關閉機蓋 →(P.19~21)
The required amount of detergent corresponding to the water level is displayed (reference only).
顯示與水位相應的洗衣劑量(參考)。

5

After washing is complete, remove the clothes
and clean the lint filter →(P.48)
完成洗衣後，取出衣物，
清潔棉絮過濾器 →(P.48)

Clean portions of garments that easily get dirty (such as the edges of quilts) with liquid detergent or special cleaning solutions beforehand in order to remove the stains.
被子的領口等容易弄髒的部分應先塗上液體洗衣劑或局部專用洗衣劑，將污漬洗掉。

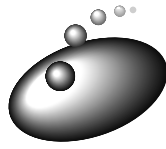

Gentle program 柔和程序

This is the course to wash use plenty of water with weak water flow.
利用充足水量，以微弱水流漂洗衣物的程序。

圖 30 (weak water flow of the machine or hand wash gently) is displayed on clothes
圖 30顯示 (洗衣機弱水流或輕柔手洗) 的衣物

Preparations 洗前準備

Washable clothes 可洗衣物	圖 30 Neutral liquid detergent or Synthetic liquid detergent. 圖 30 中性液體洗衣劑或液體合成洗衣劑 (Weak water flow of the machine or hand wash gently) is displayed. 顯示 (洗衣機弱水流或輕柔手洗) Even with the above labels, some clothes may not be washable. 即使有上述標誌，也可能無法清洗某些衣物。
Capacity 容量	3kg Max. 3kg以下
Recommended detergents 推薦洗衣劑	(Please carefully read the instructions on the detergent container to ensure proper usage.) (使用前，請仔細閱讀洗衣劑容器上列明的注意事項，正確使用。)

Usage method 使用方法

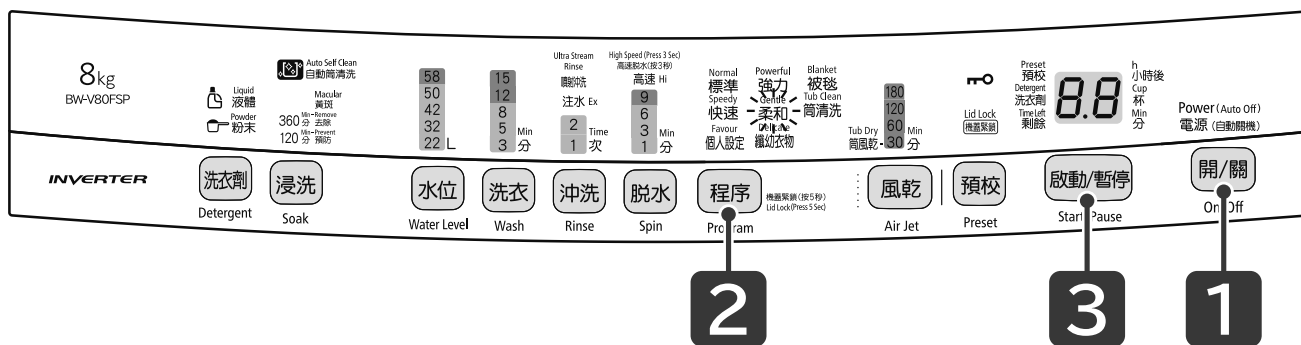

- Preparations 準備** Turn on the water tap and insert clothes
打開水龍頭，放入衣物
- 1** Press to **開/關** turn on the power
按下 **開/關**，接通電源
 - 2** Press **程序** and select the "Gentle" program
按下 **程序**，選擇“柔和”程序、
Setting of each program → (P.37)
每個程序的設置 → (P.37)
 - 3** Press **啟動/暫停**
按下 **啟動/暫停**
The machine will automatically detect the amount of clothes present.
自動檢測洗衣量。
 - 4** Add liquid detergent and fabric softener, and then close the lid
放入液體洗衣劑、柔順劑後關閉機蓋
The required amount of detergent corresponding to the water level is displayed (reference only).
顯示與水位相應的洗衣劑量(參考)。
 - 5** After washing is completed, remove the clothes
完成洗衣後，取出衣物，
and clean the lint filter → (P.48)
清潔棉絮過濾器 → (P.48)

Please do not use hot water or the water left over from your bath tub. Tap water should be used.
請勿使用熱水或剩下的浴缸水，應使用自來水。

Otherwise, clothes may shrink or become discolored due to bath gels.
否則可能導致衣物縮水或因沐浴乳造成染色。

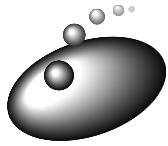

Delicate program 纖幼衣物程序











Program for cleaning fine clothes with  (hand wash gently) labels as well as clothes with  (dry clean) labels.
程序適用於清洗有  (輕柔手洗) 標誌的纖幼衣物和有  (可乾洗) 標誌衣物。

The pulsator does not rotate, but cleans clothes gently using the water flow produced by the washing • spinning basket.
葉輪不旋轉，利用洗衣 • 脫水槽轉動產生的旋轉水流，柔和地清洗衣物。



The "Delicate" program does not automatically detect the weight of the clothes.
「纖幼衣物」程序中不會自動檢測衣物量。

Preparations 洗前準備

Washable clothes 可洗衣物

Materials 質料	Wool, polyester 羊毛、聚酯纖維 ● Sweater, wool sweater 毛衣、羊毛衫 ● Casual pants, short skirt 西褲、短裙 ● Shirts, long-sleeved shirts, dresses 襯衫、長袖衫、連身裙 ● School uniforms, sailor uniforms 校服、水手服
Graphical labels used 使用圖形標誌	●  (Hand wash gently) label (輕柔手洗) 標誌 ●  (Can be partially machine washed) label (部分洗衣機可洗) 標誌 ●  (Can be dry-cleaned) label and  /  or label (可乾洗) 標誌和  或  標誌的組合 Even with the above labels, some clothes may not be washable. →(P.17) 即使有上述標誌，也可能無法清洗某些衣物。 →(P.17)
Capacity 容量	1.2kg or less 1.2kg 或以下
Clothes that cannot be washed 不可洗衣的衣物	Clothes with  (dry clean only) or  (use petroleum-based solvents) labels cannot be washed using the washing machine. 有  (禁止水洗) 標誌、  (溶劑使用石油類物質) 標誌的衣物不可用洗衣機清洗。

Detergent used 使用的洗衣劑

Graphical label used 使用圖形標誌	Detergent used 使用的洗衣劑
 (Can be dry cleaned) (可乾洗)	Special cleaning solution for clothes with dry clean labels 帶乾洗標誌衣物專用液體洗衣劑
 (Hand wash gently) (輕柔手洗)	Special cleaning solution for clothes with dry clean labels 帶乾洗標誌衣物專用液體洗衣劑
	Neutral liquid detergent 中性液體洗衣劑

Please use only liquid detergents.

請勿使用液體洗衣劑以外的洗衣劑。

Powder detergents may not fully dissolve.

粉末洗衣劑可能會無法完全融化。

Pre-treatment of clothes 衣物前處理

Preparation of clothes 衣物的準備

Please perform the following preparations before washing to prevent clothes from being damaged.
請在洗衣前做好以下準備，防止損壞衣物。

- Please turn clothes that have buttons or embroidery inside-out.
對帶鈕扣或有刺繡的衣物，請先翻轉。
- Please button up buttons and zip up zippers.
請扣上鈕扣、拉上拉鍊。
- Since clothes may dramatically shrink after washing, you can put the cardboard in an appropriate place so that it can be used to restore the clothes to their original state.
由於洗衣後可能出現大幅度縮水，因此可先將硬紙板收好，以便將衣物恢復原樣。

Check for any occurrence of discoloring. 確認是否脫色

For clothes that may be discolored, please check for any such instances.
如果是可能脫色的衣物，請事先確認是否脫色。

- Take a white towel and place some liquid detergent onto it. In a location that is not easy to notice, rub the towel onto the garment to see if any color comes off onto the towel. Clothes that lose color should not be washed.
用白毛巾沾上洗衣劑，在衣物不顯眼處用力擦拭，觀察毛巾是否染上顏色，不能清洗脫色的衣物。
- Be careful of garments that can be easily discolored (such as scarfs, etc.).
請注意容易脫色的衣物(圍巾等)。

Pre-treatment of clothes (continued) 衣物前處理(續)

Pre-washing 預洗

Please clean smudges or severe stains as soon as possible.
請盡快處理污漬或嚴重污垢。

If you don't clean them immediately, they will become difficult to clean.
如果不及時處理，會難以清洗。

You will get better results if you clean small regions first.
在洗衣前預先局部清洗，可提高洗衣效果。

How to remove smudges 去除污漬方法

- Place the garment on top of a towel, apply liquid detergent, and gently tap on the smudge using a brush to remove the smudge.
將毛巾墊在衣物後面，塗上洗衣劑原液，用刷子輕輕拍打，清除污漬。
- Garments with smudges on them should be immersed in a cleaning solution 3 times the usual concentration.
有污漬的衣物應用3倍濃度的洗衣液浸泡。
- If the smudge still cannot be removed, please use bleach.
如果仍無法去除污漬，請使用漂白劑。



Types of bleach 漂白劑的種類

Oxidized 氧化型	Oxygen-based 含氧型	Can be used on colored areas as well as on patterned areas. 可用於染色和花紋衣物。 Powder cannot be used with silk or knitted products. 如果是粉末，不可用於毛料、絲綢類衣料。
	Chlorine-based 含氯型	Cannot be used in areas with color or patterns. 不可用於染色和花紋衣物。
Reduced 還原型	Should be used when shirt collars become yellow or when garments become yellow due to iron in the water (or rust). 因水中的鐵元素而泛黃或生鏽時，以及襯衫衣領變黃時使用。 Cannot be used in areas with color or patterns. 不可用於染色和花紋衣物。	

Please carefully read the instructions on the bleach container to ensure proper usage.
使用前，請仔細閱讀漂白劑容器上列明的注意事項，正確使用。

How to clean stains in collars and cuffs. 清洗衣領、袖口等油污的方法

To clean stains in collars, cuffs, hems, and around pockets, apply liquid detergent to the area where the stain is located and brush in a single direction.
衣領、袖口、衣擺和口袋邊緣的污漬應先塗上洗衣劑原液，然後用刷子向一個方向刷洗。

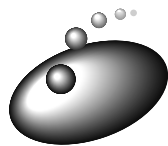

Delicate program (continued) 纖幼衣物程序（續）

Usage method 使用方法

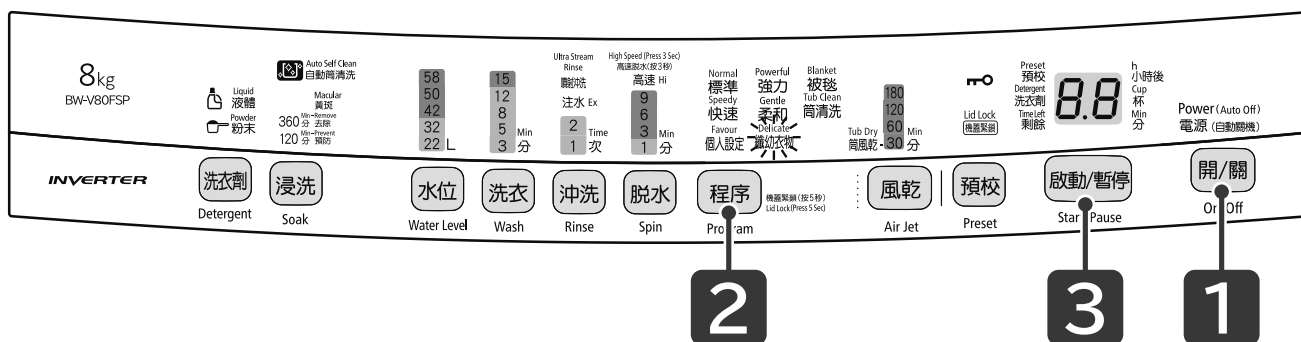

Preparations 準備

Turn on the water tap and insert clothes → (P.34)
打開水龍頭，放入衣物 → (P.34)

Allowed capacities when washing cap are used → (P.30)
使用洗衣蓋時可洗衣的容量 → (P.30)

1

Press to turn on the power
按下 ，接通電源

2

Press and select the "Delicate" program
按 選擇「纖幼衣物」程序

The water level will automatically be set to "32L."

水位將自動設為「32L」。

Changing the "water level" → (P.37、40)

Allowed water levels for: "22L" or "32L"

更改「水位」 → (P.37、40)

可選水位：「22L」或「32L」

3

Press
按下

4

Add liquid detergent and fabric softener, and then close the lid → (P.19~21)

放入液體洗衣劑、柔順劑後關閉機蓋 → (P.19~21)

The required amount of detergent corresponding to the water level is displayed (reference only).

顯示與水位相應的洗衣劑量(參考)。

5

After washing is complete, remove the washing cap, remove the clothes,
and clean the lint filter → (P.48)

完成洗衣後，取出洗衣蓋後取出衣物，

清潔棉絮過濾器 → (P.48)

Please do not use hot water or the water left over from your bath tub. Tap water should be used.

請勿使用熱水或剩下的浴缸水，應使用自來水。

Otherwise, clothes may shrink or become discolored due to bath gels.



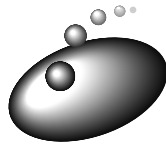



否則可能導致衣物縮水或因沐浴乳造成染色。

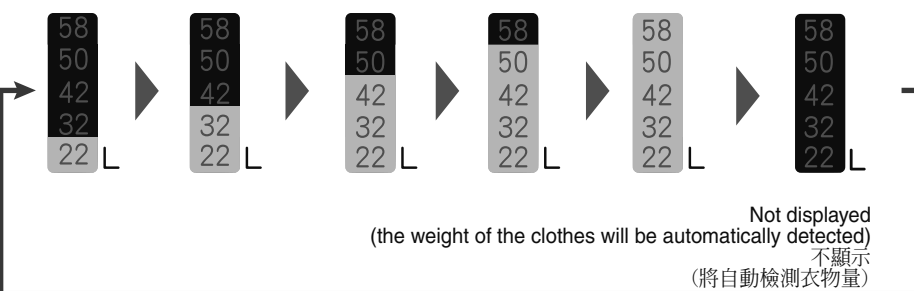

Washing in Your Favorite Way 按照您喜歡的方式進行洗衣

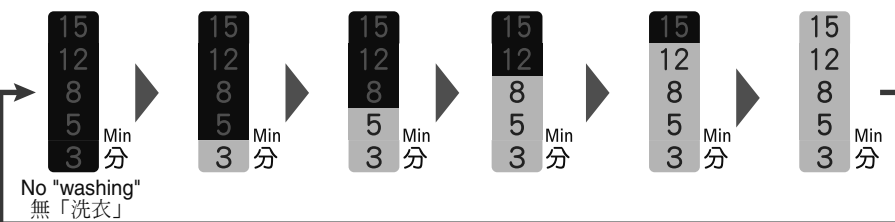
Switch between setting each time you press the button.
每次按下按鈕即可切換設定。

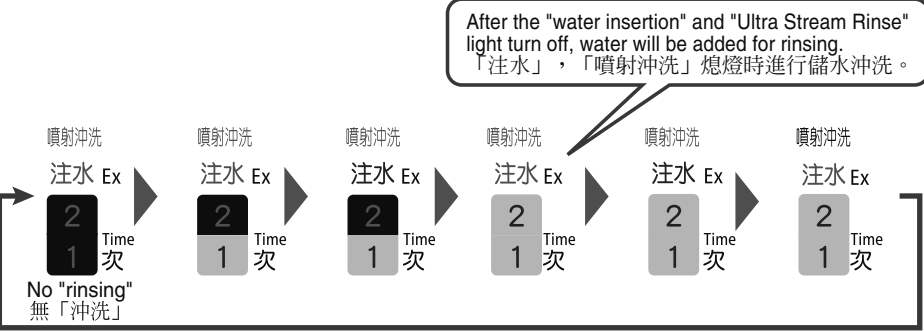
Change water level, washing, rinsing, and spinning settings 更改水位、洗衣、沖洗、脫水設定

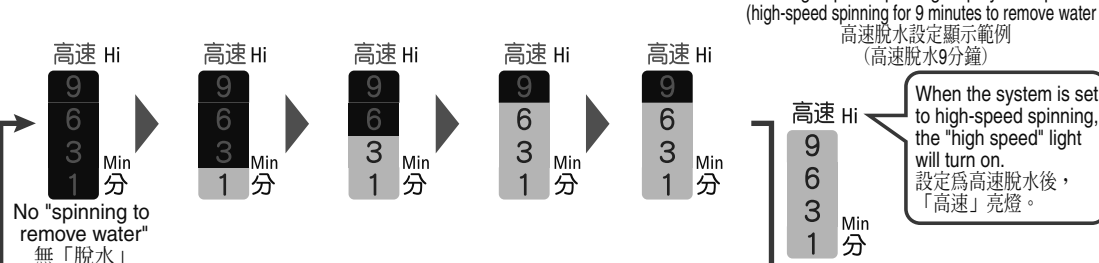
 <p>水位 Water level</p>	 <p>● If you want to add water during the washing or rinsing process, press the "water level" button. When it is pressed, water will be channeled in. (The water level will not exceed the maximum water levels for each of the programs) 如果要在洗衣或沖洗過程中加水，則按「水位」按鈕。將在按住的時候注水。(注水不會超過各程序的最高水位)</p>
 <p>洗衣 Wash</p>	 <p>No "washing" 無「洗衣」</p>
 <p>沖洗 Rinse</p>	 <p>After the "water insertion" and "Ultra Stream Rinse" light turn off, water will be added for rinsing. 「注水」，「噴射沖洗」熄燈時進行儲水沖洗。</p> <p>● Add water for rinsing: add water and then rinse. 儲水沖洗：儲水後沖洗。 ● Add water for rinsing: after adding water, the machine continues to channel in water while rinsing. 注水沖洗：儲水後，一邊注水一邊沖洗。 ● The "rinse once" program can only be set to "add water once" or "insert water once." 「沖洗 1 次」程序只能設定為「儲水 1 次」、「注水 1 次」。</p>
 <p>脫水 Spin</p>	 <p>High-speed spinning display example (high-speed spinning for 9 minutes to remove water) 高速脫水設定顯示範例 (高速脫水9分鐘)</p> <p>When the system is set to high-speed spinning, the "high speed" light will turn on. 設定為高速脫水後，「高速」亮燈。</p> <p>No "spinning to remove water" 無「脫水」</p>

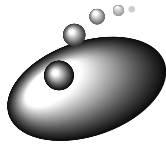

Washing in Your Favorite Way (Continued) 按照您喜歡的方式進行洗衣（續）

Stand-alone washing, rinsing, and spinning operations 單獨運行洗衣、沖洗、脫水





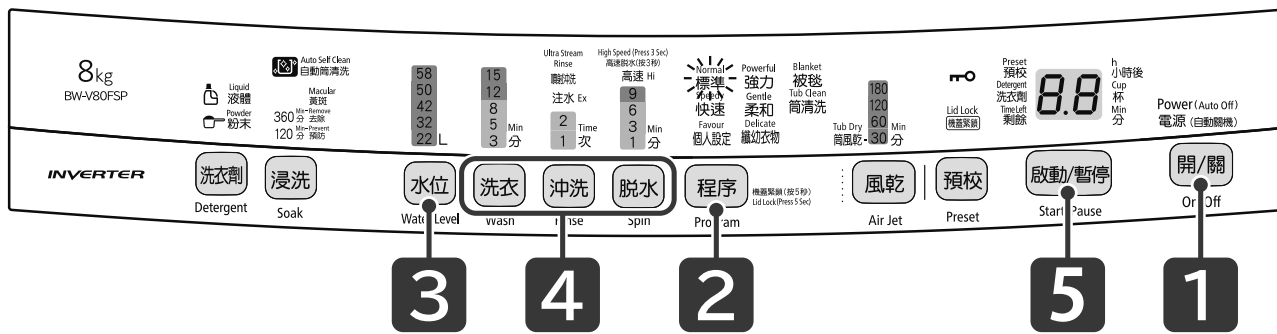







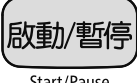



You can set water levels, washing details, rinsing details, and spinning details. You can also mix-and-match the above settings.
可設定水位、洗衣、沖洗、脫水，也可分別組合運行。

Settings are not saved. Therefore, you may want to save your frequently used programs into your "Favour" programs for later use. →(P.28)
不會儲存設定內容，因此可將常用程序輸入到「個人設定」程序中，方便使用。 →(P.28)



Under the following circumstances 在下列情況下	1	2	3	
Washing using your preferred settings 按照您喜歡的內容洗衣 Wash →rinse →spin 洗衣 →沖洗 →脫水				
Washing clothes separately 衣物分開清洗 Only washing 僅洗衣				
Clothes that easily wrinkle should not be spun 容易起皺的衣物不可脫水 Wash →rinse 洗衣 →沖洗			Select the water level 選擇水位 When the water level is not set, the machine will automatically select a water level. 沒有設定水位時，則自動決定。	
No need rinsing 不需要沖洗時 Wash →spin 洗衣 →脫水				
Rinsing clothes that have been washed 沖洗洗好的衣物 Only rinsing 僅沖洗	Press the power button to "turn on the machine" 按下電源按鈕「開」			Add water for rinsing after draining and spinning are finished. 完成排水和脫水後，再開始注入沖洗用水。
Rinse clothes that have been washed and spinning 沖洗洗好的衣物後脫水 Rinse →spin 沖洗 →脫水		Use the wash button to select "Normal" 用洗衣按鈕選擇「標準」	"50L" when the water level is not set. 沒有設定水位時，為「50L」。	Add water for rinsing after draining and spinning are finished. 完成排水和脫水後，再開始注入沖洗用水。
Spinning before dry 乾燥前脫水 Only spinning 僅脫水				When you are just draining, please use the spin button to select "1 minute." After spinning starts, press the pause button. 僅排水時，請用脫水按鈕選擇「1分」，待開始脫水後按下暫停按鈕。
Drain the water from the washing-spinning basket 排出洗衣·脫水槽中的水 Only drain water 僅排水				
There is accumulated water in the washing-spinning basket 洗衣·脫水槽中有積水 Accumulated tap water 自來水積存			Select the water level 選擇水位	Please press the wash, rinse, and (indicator lights turn off). 請按下洗衣、沖洗、脫水按鈕，

- When you are just using "Spin", the remaining time displayed will be longer than the amount of spinning time set.
僅設定「脫水」時，顯示的剩餘時間會比脫水設定時間長。
(The clothes must be distributed evenly before spinning, which takes a bit of time)
(脫水前要將衣物調整均勻，因此需要一定的時間)
- When spinning is set to "1 minute", you cannot set the machine to "Auto Self Clean".
設定為脫水「1分」時，無法設定「自動筒清洗」。

the various buttons→(P.40、41) 鈕設定內容→(P.40、41)	5	End 結束
 →  → Rinse Spin	 Start/Pause Press the start button 按下開始按鈕	The machine will operate according to the configured washing~ spinning settings. 按照設定的洗衣~脫水內容洗衣。
		Ceasing operation when there are still cleaning solutions present. 仍有洗衣液時停止運轉。
 →  Rinse		Ceasing operation when there is still bleach present. 仍有沖洗液時停止運轉。
 →  → Spin		No rinsing, just washing and spinning. 不沖洗，只洗衣和脫水。
 →  Rinse		Drain and spin before rinsing, and stopping when there is residual rinse liquid present. 沖洗前會排水和脫水，在有殘留沖洗液的狀態下停止。
 →  → Rinse Spin		Drain and spin before rinsing, and then rinsing and spinning. 沖洗前會排水和脫水，然後再沖洗、脫水。
 →  Spin		First drain water, then spin. 先排水，然後脫水。
spin buttons to change to undo settings 變為無設定(顯示熄滅)。  →  → Water Level Spin		Stop when there is accumulated tap water present. 自來水積存的狀態下停止。

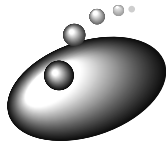

Washing in Your Favorite Way (Continued) 按照您喜歡的方式進行洗衣（續）

Operation settings and changeable settings 洗衣內容和可更改的內容

 : standard settings
 : settings that can be changed using various buttons
 : 標準設定內容
 : 各按鈕可切換的內容

Program 程序	水位 Water Level	洗衣 Wash	沖洗 Rinse	
			1st time 第1次	2nd time 第2次
Normal 標準	22~58L	8 minutes 8分	Rotate, spray, and rinse 1 time※ 旋轉噴淋沖洗 1 次※	Water-storage rinsing 儲水沖洗
	22~58L	3~15 minutes 3~15分	Water-storage rinsing 1~2 times, water-injection rinsing 1~2 times 儲水沖洗 1~2 次、注水沖洗 1~2 次	
Speedy 快速	22~46L	5 minutes 5分	Water-storage rinsing 儲水沖洗	—
	22~58L	3~15 minutes 3~15分	Water-storage rinsing 1~2 times, water-injection rinsing 1~2 times 儲水沖洗 1~2 次、注水沖洗 1~2 次	
Powerful 強力	22~50L	18 minutes (15 minutes is displayed)	Rotate, spray, and rinse 1 time※ 旋轉噴淋沖洗 1 次※	Water-storage rinsing 儲水沖洗
	22~58L	18分 (顯示為 15 分)	Water-storage rinsing 1~2 times, water-injection rinsing 1~2 times 儲水沖洗 1~2 次、注水沖洗 1~2 次	
Favour 個人設定	22~50L	8 minutes 8分	Water-storage rinsing 儲水沖洗	Water-storage rinsing 儲水沖洗
	22~58L	3~15 minutes 3~15分	Water-storage rinsing 1~2 times, water-injection rinsing 1~2 times 儲水沖洗 1~2 次、注水沖洗 1~2 次	
Gentle 柔和	50L	8 minutes 8分	Water-storage rinsing 儲水沖洗	Water-storage rinsing 儲水沖洗
	22~58L	3~15 minutes 3~15分	Water-storage rinsing 1~2 times, water-injection rinsing 1~2 times 儲水沖洗 1~2 次、注水沖洗 1~2 次	
Delicate 纖幼衣物	38L	8 minutes 8分	Water-storage rinsing 儲水沖洗	Water-storage rinsing 儲水沖洗
	22、38L	3~8 minutes 3~8分	Water-storage rinsing 1~2 times 儲水沖洗 1~2 次	
Blanket 被毯	58L	25 minutes (15 minutes is displayed)	Water-storage rinsing 儲水沖洗	Water-storage rinsing 儲水沖洗
	22~58L	25分 (顯示為 15 分)		
Tub Dry 風乾	—	—	—	
Soak 120 minutes 浸洗 120 分	22~58L	128 minutes (15 minutes is displayed)	Rotate, spray, and rinse 1 time 旋轉噴淋沖洗 1 次	Water-storage rinsing 儲水沖洗
	22~58L	128分 (顯示為 15 分)	Water-storage rinsing 1~2 times, water-injection rinsing 1~2 times 儲水沖洗 1~2 次、注水沖洗 1~2 次	
Soak 360 minutes 浸洗 360 分	38L	368 minutes (15 minutes is displayed)	Water-storage rinsing 儲水沖洗	Water-storage rinsing 儲水沖洗
		368分 (顯示為 15 分)	Water-storage rinsing 1~2 times, water-injection rinsing 1~2 times 儲水沖洗 1~2 次、注水沖洗 1~2 次	

- The required amount of time (reference only) includes the amount of time needed for adding water (15L added per minute) as well as draining.
參考所需時間包括注水時間(每分鐘注水 15L)和排水時間。
(The amount of time remaining displayed on the machine and the amount of time shown in the table will differ based on tap water water pressures, the amount of clothes present, as well as draining conditions)
(機身上顯示的剩餘時間和上表的參考所需時間因自來水水壓、洗衣量和排水條件不同而異)
- The amount of time required (reference only) is based on a room temperature of 20° C and a water temperature of 20° C.
參考所需時間為在室溫 20° C、水溫 20° C 條件下洗衣的情況。
- The "Normal", "Powerful", "Speedy", "Favour" and "Soak 120 minutes" programs will automatically detect the amount of clothes present and select the best wash settings.
「標準」、「強力」、「快速」、「個人設定」、「浸洗 120 分」程序運行時，會自動檢測洗衣量並決定最佳洗衣內容。
- Once power is turned on, the previous program will be displayed.
接通電源後，將顯示上次洗衣的程序。
(when the "Normal", "Speedy" or "Favour" "Powerful" programs are selected)
(「標準」、「快速」、「個人設定」、「強力」程序時)
- Once the "Wash" process is complete, you will not be able to change program settings.
「洗衣」程序完成後，無法更改程序內容。
- After a program starts, you will not be able to switch programs.
開始後，無法切換程序。
Please proceed after turning off power.
請關閉電源後再操作。
- If you wish the change the water level in the middle of a washing process, please press the "Pause" button, and then press the "Water Level" button.
要在沖洗過程中更改水位時，請先按下「暫停」按鈕，然後按「水位」按鈕。
- If the system is set to "Auto Self Clean", the spin time will be extended by about 5 minutes.
如果設定為「自動筒清洗」，脫水時間會延長 5 分鐘左右。
- () is the reference time duration after manually switching settings.
() 為手動進行切換設定後的參考所需時間。

脱水 Spin Wash 洗衣	風乾 Air Jet	Take note of the required time periods (may differ from actual time durations) 參考所需時間 (可能與實際時間不同)	
		Wash 洗衣	Air Jet 風乾
6 minutes 6分	—	32 minutes (20~95 minutes) 32分 (20~95分)	—
1~9 minutes 1~9分		23 minutes (10~70 minutes) 23分 (10~70分)	
3 minutes 3分	—	46 minutes (35~105minutes) 46分 (35~105分)	—
1~9 minutes 1~9分		43 minutes (20~95 minutes) 43分 (20~95分)	
6 minutes 6分	—	31 minutes (15~55minutes) 31分 (15~55分)	—
1~9 minutes 1~9分		28 minutes (15~30 minutes) 28分 (15~30分)	
6 minutes 6分	—	59 minutes 59分	—
1~9 minutes 1~9分		30, 60, 120, and 180 minutes 30、60、120、180分	
6 minutes 6分	—	160 minutes 160分	—
1~9 minutes 1~9分		400 minutes 400分	
6 minutes 6分	—		—
1~9 minutes 1~9分			

Description of time remaining
剩餘時間說明

Display example: 1 hour and 30 minutes
顯示範例：1 小時 30 分



Display example: 30 minutes
顯示範例：30 分



Display example:
顯示範例：

When more than 100 minutes
100 分以上時

When the amount of clothes is automatically detected
自動檢測衣物量時

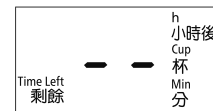

Description of information displayed (◉ represents flashing)
顯示說明 (◉ 表示閃爍)

Display example:
顯示範例：



"Loosening spinning"
in progress
「疏鬆脫水」運行中

"Amount of detergent
(0.9 cups)" displayed
「洗衣劑量 (0.9 杯)」顯示

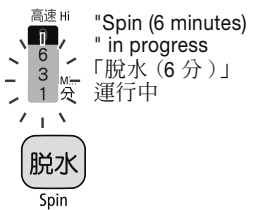



Auto Self Clean

自動筒清洗















Set to Auto Self Clean 設定為自動筒清洗

We recommend setting to "Auto Self Clean" to clean stains that you cannot see and ensure high performance.
建議始終設定為「自動筒清洗」，以便將洗衣槽中看不見的污漬清洗乾淨，讓洗衣更舒適。
It would be even better if this is used along with the "Tub Clean" program.
如果與「筒清洗」程序一起使用，洗衣過程會更舒適。→(P.51)

Programs that cannot be configured 無法設定的程序

"Blanket", "Gentle", "Delicate", "Tub Clean", "Tub Dry" programs, as well as "Air Jet" operations
「被毯」、「柔和」、「纖幼衣物」、「筒清洗」、「筒風乾」程序、「風乾」程序

Factory setting: "not set". If you need to change the settings 出廠設定為「無設定」。如需更改設定

1	Press  to power on the machine 按下  ，接通電源									
2	Then, press  to select a Normal program 然後按  選擇標準程序									
3	Press  按下  A configuration complete indication will be displayed and the user will be notified via a sound. 顯示設定完成，並以聲音告知。	▶	<table border="1"> <tr> <td style="text-align: center;"> The light will turn off 熄燈</td> <td>Not set (factory setting) 無設定(出廠時)</td> <td>A beep sound will be played as a notification. 發出「嗶」聲告知。</td> </tr> <tr> <td style="text-align: center;"> The light will turn on 亮燈</td> <td>Set 有設定</td> <td>A "beep beep" sound will be played as a notification. 發出「嗶嗶」聲告知。</td> </tr> </table>	 The light will turn off 熄燈	Not set (factory setting) 無設定(出廠時)	A beep sound will be played as a notification. 發出「嗶」聲告知。	 The light will turn on 亮燈	Set 有設定	A "beep beep" sound will be played as a notification. 發出「嗶嗶」聲告知。	
 The light will turn off 熄燈	Not set (factory setting) 無設定(出廠時)	A beep sound will be played as a notification. 發出「嗶」聲告知。								
 The light will turn on 亮燈	Set 有設定	A "beep beep" sound will be played as a notification. 發出「嗶嗶」聲告知。								
4	Press  按下  (開始洗衣，自動結束)									

- After the machine is set to "Auto Self Clean", the tub will be cleaned during the spin cycle, which is why an additional 9L of water will be used. The duration of operation will also be extended by 5 minutes.
設定為「自動筒清洗」後，會在脫水行程中清洗洗衣槽，因此用水位會增加約 9L。洗衣時間也會延長約 5 分鐘。
- After the start button is pressed, the settings will be saved.
按下啟動按鈕後，將儲存設定。
- When the settings are manually set to "spin only", "spin for 1 minute", or "do not spin", the "Auto Self Clean" will automatically be canceled (the light will turn off).
手動設定為「僅脫水」、「脫水 1 分」或「不脫水」時，「自動筒清洗」會自動解除(熄燈)。

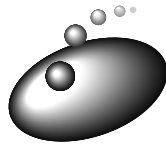

Use Ultra-Stream Rinse 使用噴射沖洗

Use plenty of water, spin at high speed and drop detergent.
使用充足水量，高速脫水以去除洗衣劑。
Recommended when you want a stronger rinse.
希望比普通洗衣更強的沖洗時建議使用。

Usage method 使用方法

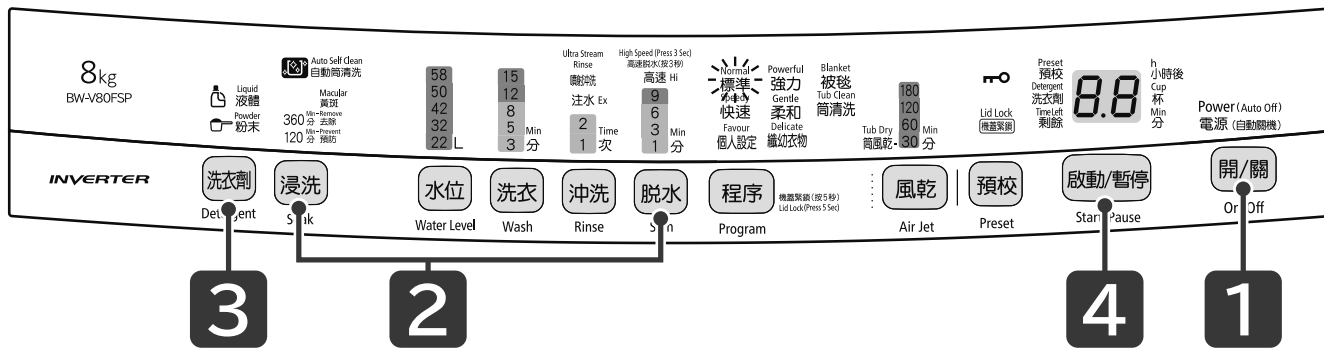

Preparations 準備	Turn on the water tap and insert clothes →(P.17~18) 打開水龍頭，放入衣物→(P.17~18)
1	Press to power on the machine 按下 ，接通電源
2	Press to select a "Normal" "Powerful" "Favour" program 按下 ，選擇“標準”“強力”“個人設定”程序、 or press , to select a program 或按下 ，選擇程序 Once you press , "Soak" can be selected. 當按下 , “浸洗”程序可被選中。
3	Press to select "Ultra Stream Rinse" or "Rinse", when "Ultra Stream Rinse" is selected, 按下 選擇“噴射沖洗”或“沖洗”，當“噴射沖洗”被選中時， Ultra Stream Rinse will be displayed. "Normal" program will turn on, press and for setting. “噴射沖洗”顯示點亮。“標準”程序時，按下 和 再設定。
4	Press 按下 The machine will automatically detect the amount of clothes present and then display the amount of water and detergent required (reference only). 將自動檢測洗衣量，然後顯示水位和洗衣劑量(參考)。
5	Add the recommended amount (reference only) of detergent, 按照洗衣劑量(參考) bleach, and fabric softener, and then close the lid →(P.19~21) 放入洗衣劑、漂白劑和柔順劑後關閉機蓋 →(P.19~21)
6	After washing is completed, remove the clothes 完成洗衣後，取出衣物， and clean the lint filter →(P.48) 清潔棉絮過濾器 →(P.48)

After washing is completed, the setting of Ultra-Stream Rinse is automatically cancelled.
Please set it whenever washing.
完成洗衣後，噴射沖洗的設定將自動取消。

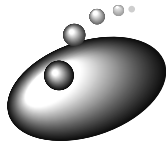

Preset 預校

The duration of operation can be set to be anywhere between 3~24 hours (in units of 1 hour).
可將洗衣完成時間設定在 3~24 小時之間，以小時為單位。
It is convenient to have the machine operate when you are out of the house or at night.
外出或夜間洗衣時非常方便。

How to use the scheduling button (switching between settings) 預校按鈕的使用方法（切換內容）

The preset time is the time at which operation will end.
預校時間是指洗衣結束預定時間。

For example, if you want the machine to stop in 3 hours, the preset time would be "3 hours."
例如，想要在3小時後結束時，預校時間為“3小時”。

Press  to switch between settings.

每次按下  即可切換設定。

(Press and hold to continually switch between time settings)

(長按時，連續切換預約時間)



(display for the 3-hour setting)
(3 小時後的顯示範例)

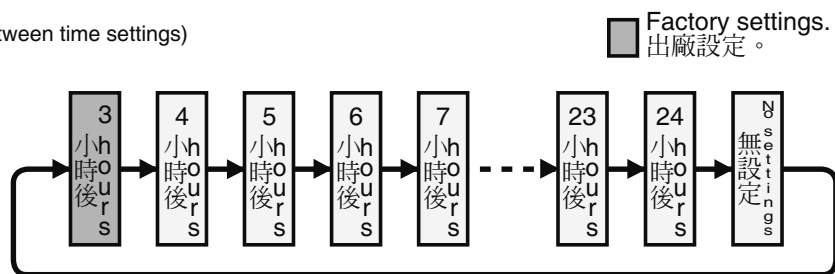



Can be set to 3~24 hours 可設定為 3~24 小時後	The "Program" and "Soak for 120 minutes" programs. 「程序」 「浸泡 120 分」程序
Can be set to 7~24 hours 可設定為 7~24 小時後	The "Soak for 360 minutes" program 「浸泡 360 分」程序

Programs that cannot be configured 無法設定的程序

- The "Delicate", "Gentle", "Tub Clean", and "Tub Dry" programs
「纖幼衣物」、「柔和」、「筒清洗」、「筒風乾」程序
- "Air Jet" program
「風乾」程序

At this time 此時

Confirm preset schedule settings: press  (the preset schedule settings are displayed when pressed)

確認預校內容：按下  (按住時顯示預校內容)

Cancellation of preset schedule setting: press  to turn off power (when the power cord is unplugged, or when there is a power outage, the preset schedule settings will be cancelled)

取消預校：按下 ，切斷電源(拔下電源插頭時，或停電時，將取消預校洗衣)

Changing preset schedule settings: press  to turn off the power and restart operation

更改預校：按下 ，切斷電源，重新設定

Adding clothes: add clothes without turning off the power (when adding clothes for a preset schedule, try not to add too many clothes to allow for thorough cleaning)

添加衣物：不切斷電源直接添加衣物(預校中添加衣物時，應盡量不要添加太多。如果衣物過多，會洗不乾淨)

- Schedules may change based on the quantity of clothes, material types, the water level, as well as water draining conditions.
根據衣物量、質料、注水量、排水條件不同，預定時間可能會發生變化。
- When engaging in pre-scheduled operation, do not put in clothes prone to discoloration with other clothes.
預校洗衣時，請勿放入容易染色的衣物一起清洗。
- In order to prevent clothes from becoming wrinkled, please remove clothes from the machine to dry as quickly as possible after washing is complete.
為防止衣服起皺，洗衣結束後請盡快取出衣物晾曬。
Leaving them in the machine for too long may result in odors.
如果長時間放置，可能產生異味。
- After you schedule a certain operation, if you wish to change your operation settings, please drain the water from the washing • spinning basket before engaging in the subsequent operation.
設定預校後，更改設定內容並洗衣時，請先將洗衣 • 脫水槽中的水排出後再洗衣。

Usage method 使用方法

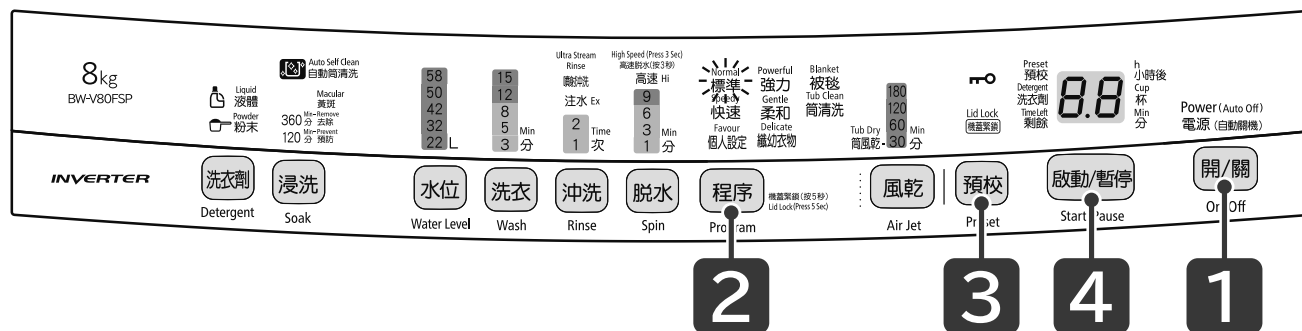

- Preparations
準備** Turn on the water tap and insert clothes → (P.17、18)
打開水龍頭，放入衣物 → (P.17、18)
- 1** Press **開/關** to turn on the power
按下 **開/關**，接通電源
 - 2** Press **程序** to select a program
按 **程序** 選擇程序

A different program is selected each time it is pressed.
每按一次更改所選的程序。

Detailed settings → (P.24)
詳細設定 → (P.24)
 - 3** Press **預校** and set the time to stop the operation
按下 **預校**，設定完成洗衣時間
 - 4** Press **啟動/暫停**
按下 **啟動/暫停**

The machine will automatically detect the amount of clothes present and then display the amount of water and detergent required (reference only). → (P.20)
將自動檢測洗衣量，然後顯示水位和洗衣劑量(參考)。→ (P.20)
If water has already been added to the washing·spinning basket, then the machine will not perform detection.
如果已事先在洗衣·脫水槽中放好水，則不會檢測。
 - 5** Add the recommended amount (reference only) of detergent, bleach, and fabric softener, and then close the lid → (P.19~21)
按照洗衣劑量(參考)
放入洗衣劑、漂白劑和柔順劑後關閉機蓋 → (P.19~21)

After the wash settings are displayed, only "pre-scheduling" is lighted.
顯示洗衣內容後，只有「預定」點亮。
 - 6** After washing is complete, remove the clothes and clean the lint filter → (P.48)
完成洗衣後，取出衣物，
清潔棉絮過濾器 → (P.48)

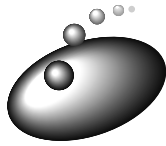







Convenient usage methods 方便的使用方法

Changing or turning off the sound notifications for operation commencement and operation completion 更改或關閉洗衣開始音和結束音

Changing the music for operation commencement and operation completion.
可更改洗衣開始和結束時的音樂。

Factory setting: "music." If you need to change the settings
出廠設定為「音樂」。如需更改設定

- 1 Press  to power on the machine
按下 , 接通電源
- 2 Press  for 3 seconds or more
按  3 秒以上
- 3 Press  to cut off power (It will end when the power is cut off)
按下 , 切斷電源 (切斷電源後結束)



- Once configuration operations are complete, the set sound will be played. When silent (with button sounds), a "beep" sound will be played, which means that configuration is complete. 設定完成後，將響起設定的聲音。靜音(有按鈕聲)時，響起「嗶」，表示設定完成。
- The changed settings will be saved even when the power is cut off. Use the same steps to change the settings. 即使切斷電源後，也會儲存更改的內容。更改設定時，以相同的步驟操作。

Turning off the pre-completion notification sound 關閉結束預告音

The notification sound will be played 10 minutes prior to completion of an operation
洗衣結束前 10 分鐘以預告音告知。

Factory setting: "set(music)." If you need to change the settings
出廠設定為「有設定(有音樂)」。如需更改設定



- 1 Press  to power on the machine
按下 , 接通電源
- 2 Press  for 3 seconds or more
按  3 秒以上
You will hear a "beep" sound. Continue pressing.
會響起「嗶」的響應聲，請繼續按住。
Switch between displays each time it is pressed.
每次按下即可切換設定。
- 3 Press  to cut off power (It will end when the power is cut off)
按下 , 切斷電源 (切斷電源後結束)



- During spinning, if spinning is restarted due to uneven distribution of clothes, the completion notification sound will not be played. 脫水過程中，因衣物偏置而重新脫水時，不會響起結束預告音。
- The changed settings will be saved even when the power is cut off. Use the same steps to change the settings. 即使切斷電源後，也會儲存更改的內容。更改設定時，以相同的步驟操作。

Applying detergent twice 使用 2 次洗衣液

Clothes with light stains and clothes with heavy stains can be washed separately.
可將污漬較少的衣物和較多的衣物分兩次清洗。

- 1 Wash the clothes with less stains first
先清洗污漬較少的衣物

- 2 Then, wash the clothes with heavy stains
然後清洗污漬較多的衣物

- 3 Place the first batch of clothes in the washing·spinning basket
將第一次洗完的衣物放入洗衣·脫水槽
Clothes from the first run
第一次的衣物

- 4 Washing complete
洗衣結束

- 1 Only set to "wash"
僅設定為「洗衣」→(P.38)
- 2 Insert detergent according to the water level
根據水位放入洗衣劑
- 3 After washing is complete, remove the wet clothes
「洗衣」結束後，取出濕衣物
- 1 Use the detergent from the first run to engage in the program of your choice("wash→rinse→spin")
利用第一次的洗衣液，按照您喜歡的程序洗衣(「洗衣→沖洗→脫水」)
- 2 Set the water level according to the amount of clothes
根據衣物量設定水位
- 3 After washing is complete, remove the clothes
洗衣結束後，取出衣物
- 1 Set to "rinse→spin"
設定為「沖洗→脫水」→ (P.39)
- 2 Set the water level to the same setting as the first time
設定與第一次相同的水位



Set to high-speed spinning 設定為高速脫水



High-speed spinning is performed at 1000 rpm, thoroughly removing water from the clothes and reducing the amount of time required for drying. 以 1000 轉/分的速度高速脫水，充分甩乾衣物中的水分，縮短晾曬時間。

Programs and operations that cannot be configured 無法設定的程序和運轉



"Gentle", "Delicate" "Air Jet", "Tub Clean" programs, as well as the "Air Jet" operation
「柔和」、「纖幼衣物」、「風乾」、「筒清洗」程序、「風乾」程序

Factory setting: "not set". If you need to change the settings
出廠設定為「無設定」。如需更改設定

1 Press  to power on the machine
按下 , 接通電源

2 Press  for 3 seconds or more
按  3 秒以上
You will hear a "beep" sound. Continue pressing.
會響起「嗶」的響應聲，請繼續按住。
A configuration complete indication will be displayed and the user will be notified via a sound.
顯示設定完成，並以聲音告知。



	The light will turn off 熄燈	Not set (800 rpm) (factory setting) 無設定 (800 轉/分) (出廠時)	You will hear a "beep" sound as a notification 發出「嗶」聲告知
	The light will turn on 亮燈	Set (1000 rpm) 有設定 (1,000 轉/分)	You will hear a "beep" sound as a notification 發出「嗶」聲告知



3 Press  to cut off power
按下 , 切斷電源 ● The changed settings will be saved even when the power is cut off. Use the same steps to change the settings.
即使切斷電源後，也會儲存更改的內容。更改設定時，以相同的步驟操作。

Extending the rotation, water insertion, and rinsing durations 延長噴淋沖洗時間



The rotation, water insertion, and rinsing durations can be extended.
可延長噴淋沖洗時間

Factory settings: "not set." If you need to change the settings
出廠設定為「未設定」。如需更改設定

1 Press  to turn on the power
按下 , 接通電源

2 Press  for 3 seconds or more
按  3 秒以上
A configuration complete indication will be displayed and the user will be notified via a sound.
顯示設定完成，並以聲音告知。



	Not set (factory setting) 未設定 (出廠時)	You will hear a "beep" sound as a notification 發出「嗶」聲告知
	Set 有設定	You will hear a "beep" sound as a notification 發出「嗶」聲告知



3 Press  to cut off power
按下 , 切斷電源 ● The changed settings will be saved even when the power is cut off. Use the same steps to change the settings.
即使切斷電源後，也會儲存更改的內容。更改設定時，以相同的步驟操作。

Setting of maximum water Level 最高水量的設定

The water level will be automatically set according to the amount of laundry, or you can change the water level.
根據洗滌物會自動設定水量，也可以改變設定設置更多的用水量

Factory setting: "not set." If you need to change the settings
出廠設定為「未設定」。如需更改設定

1 Press  to turn on the power
按下 , 接通電源

2 Press  for 3 seconds or more
按  3 秒以上
You will hear a "beep" sound. Continue pressing.
會響起「嗶」的響應聲，請繼續按住。
A configuration complete indication will be displayed and the user will be notified via a sound.
顯示設定完成，並以聲音告知。

	Not set (factory setting) 未設定 (出廠時)	You will hear a "beep" sound as a notification 發出「嗶」聲告知
	Set 有設定	You will hear a "beep" sound as a notification 發出「嗶」聲告知

3 Press  to cut off power
按下 , 切斷電源 ● The changed settings will be saved even when the power is cut off. Use the same steps to change the settings.
即使切斷電源後，也會儲存更改的內容。更改設定時，以相同的步驟操作。

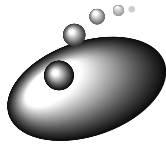

Maintenance

維修保養

In order to extend usage life, please frequently perform maintenance. The following is a description of maintenance methods.
爲了延長使用壽命，請經常進行保養。下面介紹保養方法。

Lint filter 棉絮過濾器

Please perform maintenance after each cleaning effort.
請在每次洗衣結束後進行保養。

1	Remove the lint filter 拆下棉絮過濾器 1 Press on the claw of the lint filter (upper portion) 按住棉絮過濾器的搭扣(上部) 2 Turn it outward and remove 向外拉出，拆下	
2	Open the filter tray. Hold both sides and pull out. 打開過濾網盒，握住兩側拉出。	
3	Remove the lint and any other objects from the lint filter 清除棉絮過濾器中黏附的棉絮，將堵塞物清洗乾淨。 Install the filter after washing. Please push the filter into the lint until you hear the "click" sound. 洗淨後將過濾器安裝好，請將過濾器推入過濾網，直至聽到「咔嚓」的聲音。	
4	Close the filter cover, and re-install the lint filter 關上過濾器蓋，將棉絮過濾器安裝到原位 1 Re-insert the claw (lower portion) of the lint filter into its original position 將棉絮過濾器的搭扣(下部)扣入原位 2 Press the claw (upper portion) of the lint filter inward until you hear a "click" sound The lint filter may fall off during operation. 向內按棉絮過濾器的搭扣(上部)，直至聽到「咔嚓」聲 棉絮過濾器可能在運轉過程中脫落。	

- When the lint filter is removed, please be sure not to let any objects such as hairpins or coins fall into the washing • spinning basket slot.
拆下棉絮過濾器時，請勿讓髮夾、硬幣等物品掉入洗衣•脫水槽的底部。
- Please do not engage in washing when the lint filter is removed. Otherwise, the clothes could be damaged.
拆下棉絮過濾器時請勿洗衣。否則可能損傷衣物。

Notes The lint filter is a consumable item. If it is damaged, please purchase a new one at a licensed repair shop. →(P.60)
注意 棉絮過濾器爲消耗品。如果損壞，請到特約維修站購買。→(P.60)

The machine body as well as the washing · spinning basket 機身、洗衣·脫水槽

Please clean when there are water droplets or stains.
有水滴附著或有污漬時，請盡快清理。

- When there are water droplets or stains, or when detergent or fabric softener gets onto plastic handles (or other plastic portions of the machine) or metal parts, please clean with a soft cloth. If left uncleaned, it may result in damage or rust, which would in turn result in damage to the machine.
機身有水滴、污漬，或把手等塑料部件、金屬部件沾到洗衣劑、柔順劑時，請用軟布擦拭。如果放置不管，可能造成損傷或生鏽，損壞機器。
- Please do not pour water directly onto any portion of the machine.
請勿直接向機身的任何部位灑水。
- The glass portion of the machine lid should be cleaned with a soft cloth. Otherwise, rust or damage could occur in the surrounding components.
請用軟布擦拭機蓋的玻璃面。請勿使用化學藥品或玻璃清潔劑。否則可能導致周圍部件生鏽或損壞。
- Please do not use benzene, thinners, cleaning agents, alkaline detergent, weak alkaline detergent, paraffin, or scouring pads for cleaning.
請勿用揮發油、稀釋劑、清洗劑、鹼性洗衣劑、弱鹼性洗衣劑、石蠟等擦拭，或用百潔布摩擦。
- Please remove rust from the washing · spinning basket using a cleanser. Do not use iron balls, etc.
請用潔面乳擦拭洗衣·脫水槽的鏽漬。請勿使用鋼絲球等。
- The stainless steel tub is rust-proof, but rust may still occur in the following circumstances:
不銹鋼筒是防鏽的，但在以下情況下可能也會生鏽。
 - Objects such as hairpins come into contact with the washing · spinning basket for long periods of time, or water that contains iron powder or rust is used.
髮夾等物品長期與洗衣·脫水槽接觸，使用混有鐵粉或鐵鏽的水。
 - Place bleach that contains chloride, detergent, or fabric softener on metal portions of the machine around the washing · spinning basket for long periods of time.
將含氯漂白劑、洗衣劑、柔順劑長期放置在洗衣·脫水槽周圍的金屬部位。
- After the machine stops, water in the pipes might flow out from the water inlet. Please wipe with a soft cloth.
洗衣結束後，水管中殘留的水可能會從注水口流出，請用軟布擦拭。
- If the washing · spinning basket has stains or odors, please use the "Tub Clean" program; To prevent rust from occurring in the washing · spinning basket, please execute the "Tub Dry" program.
如果洗衣·脫水槽有明顯污漬或異味，請運行「筒清洗」程序；如果要防止洗衣·脫水槽生鏽，請運行「筒風乾」程序。→(P.51)

Detergent feeding case (detergent · bleach feeding case) 洗衣劑投入盤 (洗衣劑 · 漂白劑投入口)

If there is detergent or bleach residue, or if there are any stains, please remove and clean.
如果有洗衣劑、液體漂白劑黏附或有污漬，請拆下後清洗。

1

Remove the detergent feeding case
拆下洗衣劑投入盒

- 1 Push the detergent feeding case upward and then push it toward the side
將洗衣劑投入盒向上推，然後將一側向裏面推
- 2 Remove the bolts from their respective sockets
分別將栓子從栓孔中拆下

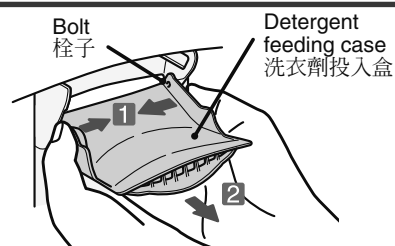

2

Clean off the stains
清洗污漬

If the stains are more severe, please immerse in hot water (approximately 40°C) for about 5 minutes and then clean with a tooth brush.
如果污漬較嚴重，請在熱水(約40°C)中浸泡約5分鐘，然後用牙刷等清洗。

3

Wipe off the water and re-install
擦乾水分，按原樣安裝

- 1 Insert the bolts of the detergent feeding case into their sockets one-by-one
將洗衣劑投入盒的栓子一個一個地插入投入口的栓孔中

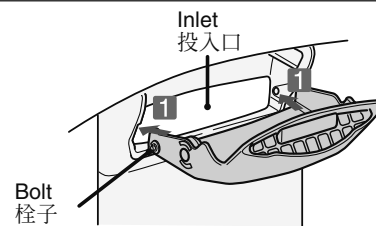

Fabric softener feeding case 柔順劑投入盒

If there is fabric softener residue or if there are any stains, please clean with water.
如果有柔順劑黏附或有污漬，請用水沖洗。

1

Remove the fabric softener feeding case
拆下柔順劑投入盒

- 1 Pull the fabric softener feeding case outward as far as you can
將柔順劑投入盒向外拉，直至拉不出
- 2 Push the fabric softener feeding case to the left, and then pull it outward again.
向左推柔順劑投入盒，然後再向外拉

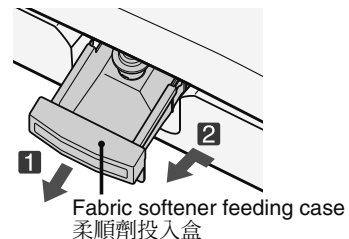

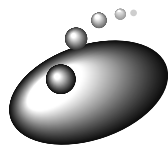

Maintenance (continued) 維修保養 (續)

2

Remove the cover of the fabric softener feeding case and clean off the stains
將柔順劑投入盒的蓋子取下，清洗污漬

- Please clean any softener off of the softener feeding case, the lid, as well as the lid sockets.
請清洗柔順劑投入位、蓋子、蓋孔等沾有柔順劑的部位。
- If the stains are more severe, please immerse in hot water (approximately 40°C) for about 5 minutes and then clean with a tooth brush.
如果污漬較嚴重，請在熱水(約40°C)中浸泡約 5 分鐘，然後用牙刷等清洗。
- If it is frozen, please place the softener feeding case in hot water (approximately 40°C)
如果凍結，請在柔順劑投入盒中放入熱水(約40°C)。

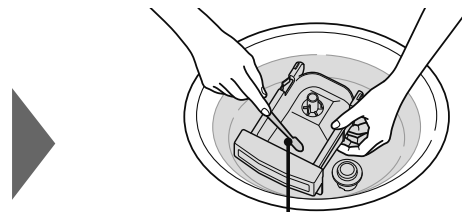
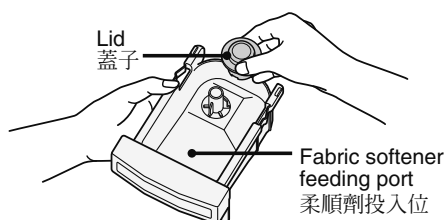

Clean off stubborn stains with a tooth brush
頑固污漬用牙刷清洗

3

Wipe off the water and re-install
擦乾水分，按原樣安裝
Please confirm that the lid has been installed.
請確認已裝上蓋子。

Near the fabric softener feeding case socket 柔順劑投入盒插入口附近

Please wipe with a wet cloth periodically (once per week) or when there are fabric softener residue or stains.
請定期(1次/週)或在有柔順劑黏附、有污漬時，用濕布擦拭。

1

Remove the fabric softener feeding case
拆下柔順劑投入盒

2

Use a wet cloth to clean the area around the fabric softener feeding case
用濕布擦拭柔順劑投入盒周圍

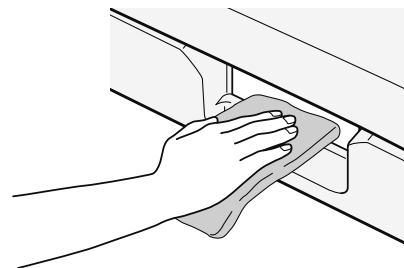

3

Re-install the fabric softener feeding case the way it was
將柔順劑投入盒按原樣安裝



When freezing could occur
有可能結冰時

1

Close the water faucet and remove the inlet water hose.
(Removal method  11)
關閉水龍頭，拆下供水管。(拆卸方法  11)

2

Face the hose downward, but do not let it bend.
將供水管朝下，但不能讓其彎曲。
· This is to prevent the water that is still in the hose from flowing out.
· 以免殘留在供水管中的水流出。

3

Select the "Tub Clean" program and cease operation after 30 seconds.
選擇「筒清洗」程序，運轉 30 秒鐘後停止運作。
· This will allow all of the remaining water in the inlet water hose to flow out.
· 可將殘留在供水管中的水全部排出。

4

Put down the water drainage hose.
放下排水管。

5

Set "Spin" for 30 seconds.
設定「脫水」，運轉 30 秒。

6

Turn off the power.
關閉電源開關。
· In order to allow water from the basket and the drain hose to flow out, the drain valve should be kept in an open state.
· 為排出筒內和排水管中的水，應使排水閥保持開啓狀態。

If freezing has already occurred 如果已經結冰時

1

Remove the water supply hose and place it into water with a temperature of about 40°C.
卸下供水管，放入 40°C 左右的溫水中。

2

Pour warm water with a temperature of about 40°C into the water feeding case.
在供水口中倒入 40°C 左右的溫水。

3

Pour warm water with a temperature of about 40°C into the basket.
在筒內倒入 40°C 左右的溫水。

4

Then, connect the hose with the water faucet and check whether water enters the washing machine properly, whether the draining of water is performed properly, and whether the water inlet operations properly.
再將供水管接到水龍頭，檢查洗衣機是否正常供水、排水，供水口是否運作正常。

Notes 注意

After water is turned off and the water supply hose is temporarily removed, please turn off the water faucet, select the "Tub Clean" program, press the start button, and slowly turn on the water faucet.
停水後及暫時拆卸供水管後再裝配的情況下，請關閉水龍頭，選擇「筒清洗」程序，按下啟動按鈕，慢慢打開水龍頭。

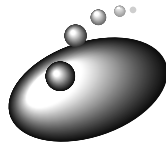

Tub Clean·Tub Dry program 筒清洗·筒風乾程序

Programs recommended to be used when the washing·spinning basket has stains or odors, or in order to prevent rusting.
洗衣·脫水槽有明顯污漬或異味時，或者要防止生鏽時，建議運行的程序。

Different ways to use the program 程序的不同用法

Program 程序	At this time 此時	Operation time 運轉時間
Tub Clean 筒清洗	When the washing·spinning basket is dirty or has odors. 洗衣·脫水槽明顯髒污或有異味時	11 hours 11小時
		3 hours 3小時
Tub Dry 筒風乾	Prevent mold from forming in the washing·spinning basket 防止洗衣·脫水槽發霉	30 minutes 30分鐘



Tub Clean program 筒清洗程序

Please use when the washing·spinning basket is clearly dirty or has clear odors.

請在洗衣·脫水槽明顯髒污或有異味時使用。

Clean soap residue or black mold from the washing·spinning basket using a tub cleaning solution and then let it dry for 30 minutes to remove odors.
使用洗衣·脫水槽清洗劑等，將洗衣·脫水槽中堆積的肥皂沫或黑色霉斑洗淨，然後晾乾 30 分鐘左右去除異味。

- Washing·spinning basket operations ※The 11-hour program and the 3-hour program stop at different times.
洗衣·脫水槽的運轉 ※11 小時程序和 3 小時程序的停止時間不同。

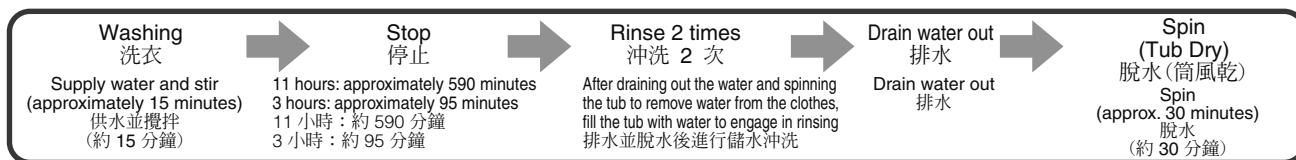

- When odors are present:
有異味時:

11-hour program
11小時程序

Generally, after long periods of usage, soap residue will accumulate and black mold may grow, which can easily cause odors.
一般情況下，長時間使用後會有肥皂沫堆積或產生黑色霉斑，容易產生異味。

When there is an odor, please run the 11-hour program.
有異味時，請運行 11 小時程序。

- To suppress odors:
要抑制異味:

3-hour program
3小時程序

- In order to remove soap residue or suppress odors, we recommend periodically running the 3-hour program.
要清除黏附的肥皂沫或抑制異味，建議定期運行 3 小時程序。
(we recommend once every 1~2 months)
(建議每 1~2 個月一次)
- It can also be used when lint attaches onto clothes.
衣物上有棉絮黏附時也可使用。
No tub cleaning solutions are needed for this.
此時，無需洗衣·脫水槽清洗劑。

When using tub cleaning solutions 使用洗衣·脫水槽清洗劑等時

- Please use chlorine-based garment bleaches or chlorine-based tub bleaches.
請使用衣物用含氯漂白劑，或洗衣機筒用含氯漂白劑。
- If you want a thorough cleaning, please use the specialized cleaning solution for washing machine basket:
"Chlorine-based bleach with anti-corrosion substances added."
想要徹底清洗時，請使用洗衣機筒專用的洗衣·脫水槽清洗劑「添加有防腐蝕劑的含氯漂白劑」。
- If the washing·spinning basket cleaning solution or bleach is labeled with instructions on cleaning frequencies and usage amounts, please follow accordingly.
如果洗衣·脫水槽清洗劑或各種漂白劑上標示有洗衣頻率和用量，請按標示使用。
- If usage amounts are not labeled, please use around 500mL.
如果沒有標示用量，請使用約 500mL。
- Please do not use bleaches that contain chlorine or bleaches for kitchen use.
請勿使用含氯漂白劑或廚房用漂白劑。
Excessive bubbles may cause leakages.
由於較多泡沫，可能導致漏水。
- When inserting into the washing·spinning basket, please be careful not to get any onto the surface of the machine.
放入洗衣·脫水槽時，請注意不要沾到機身表面。
If some gets onto the surface of the machine, please wipe clean immediately.
如果沾到，請立即擦乾淨。



When continually using the Auto Self Clean function 持續使用自動筒清洗時

- If you continually use the Auto Self Clean, we recommend using it once every 3~4 months. Use a bleach that contains chlorine or a basket cleaning bleach that contains chlorine.
如果有持續使用自動筒清洗，建議每 3~4 個月一次，用衣物用含氯漂白劑或洗衣機筒用含氯漂白劑運行 3 小時程序。

Tub Dry program 筒風乾程序

Please use to prevent mold from growing in the washing·spinning basket.
想要防止洗衣·脫水槽發霉時請使用。

You can air-jet the washing·spinning basket for about 30 minutes to suppress the growing of black mold.
可用約 30 分鐘風乾洗衣·脫水槽，抑制黑色霉菌的產生。

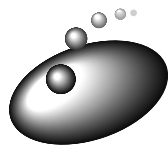

Tub Clean·Tub Dry program 筒清洗·筒風乾程序 (續)

Usage method 使用方法

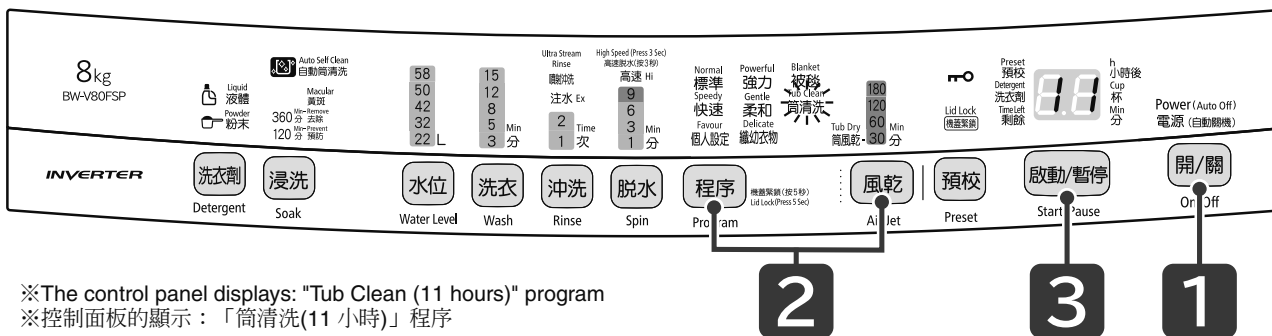

※The control panel displays: "Tub Clean (11 hours)" program
※控制面板的顯示：「筒清洗(11小時)」程序

When using the "Tub Clean" program 「筒清洗」程序時

Preparations 準備	Turn on the water faucet 打開水龍頭
1	Press to turn on the power 按下 ，接通電源
2	Press, and select the "Tub Clean (11 hours)" or the "Tub Clean (3 hours)" program 按下 ，選擇「筒清洗(11小時)」或「筒清洗(3小時)」程序 <div style="display: flex; justify-content: space-around;"> <div style="text-align: center;"> <p>Tub Clean (11 hours) 筒清洗 (11小時)</p> </div> <div style="text-align: center;"> <p>Or</p> </div> <div style="text-align: center;"> <p>Tub Clean (3 hours) 筒清洗 (3小時)</p> </div> </div> <p>Press the button to switch between durations. 每次按下按鈕即可切換時間。</p> <p>Directly add basket cleaning solutions or chlorine-based garment bleach into the washing·spinning basket. 直接將洗衣機筒清潔劑或衣物用氯漂白劑放入洗衣·脫水槽中。 Please do not spill any onto the surface of the machine. 請注意不要沾到機身表面。 If it does, the solution should be wiped off immediately. 如果沾到，請立即擦乾淨。</p>
3	Close the lid, Press 關閉機蓋，按下 The following will be displayed. 變為如下顯示。 <div style="display: flex; justify-content: space-around;"> <div style="text-align: center;"> <p>When the machine has just been started 剛啟動時</p> </div> <div style="text-align: center;"> <p>99 minutes remaining 剩餘 99 分</p> </div> <div style="text-align: center;"> <p>End 結束</p> </div> </div> <p>Between just started~"100 minutes remaining" 剛啟動~剩餘「100分」之間 After the "99 minutes remaining" message is displayed, the time will be decremented minute by minute until the operation ends. (99→98→...45→44→...3→2→1) 顯示剩餘時間「99分」後，以1分為單位逐漸減少時間，直至結束。(99→98→...45→44→...3→2→1)</p>
4	After operation ends, and clean the lint filter→(P.48) 完成運轉後，清潔棉絮過濾器→(P.48)

When using the "Tub Dry" program 「筒風乾」程序時

Preparations 準備	The water faucet does not need to be turned on 不需要打開水龍頭
1	Press to turn on the power 按下 ，接通電源
2	Press and select the "Tub Dry 30 minutes" program 按下 ，選擇「筒風乾 30 分」程序 <div style="text-align: center;"> <p>Tub Dry 30 minutes 筒風乾 30 分</p> </div> <p>The information displayed for "Air Jet for 30 minutes" and "Tub Dry for 30 minutes" is the same. 「風乾 30 分」和「筒風乾 30 分」的顯示相同。</p>
3	Close the lid, 關閉機蓋， Press 按下 The following will be displayed. 變為如下顯示。 <div style="display: flex; justify-content: space-around;"> <div style="text-align: center;"> <p>30 minutes remaining 剩餘 30 分</p> </div> <div style="text-align: center;"> <p>End 結束</p> </div> </div> <p>After the "30 minutes remaining" message is displayed, the time will be decremented minute by minute until the operation ends. (30→29→...10→9→8→...3→2→1) 顯示剩餘時間「30分」後，以1分為單位逐漸減少時間，直至結束。(30→29→...10→9→8→...3→2→1)</p>
4	After operation ends, and clean the lint filter→(P.48) 完成運轉後，清潔棉絮過濾器→(P.48)

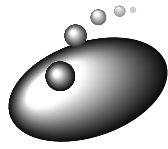

When Failure Happens 有故障發生時

About the abnormality alarm 關於異常警報

In the following cases, the flash of indicator and the sound of buzzer will announce the abnormality. If the washing machine generates unexpected error alarm, the washing machine shall be temporarily suspended for a while, and then restarted. If the same error alarm occurs again, please follow the following steps.

出現下列情況時，將通過指示燈的閃動和蜂鳴器聲警告知您發生異常。但若洗衣機出現意外的錯誤警報時，應先暫停機器，然後再次啟動。若再次出現同樣的錯誤警報，請按以下步驟進行檢查。

DISPLAY	Alarm content 警報內容	Part to check 檢查部位	Solution 處理方法
	Too much laundry 洗衣量過多	<ul style="list-style-type: none"> Don't put in too much laundry. 不要放入過多洗滌物。 The amount of laundry than can be washed varies depending on the type, size, and material of items. 能夠洗滌的洗衣量會因種類、大小、布料而異 	Troubleshooting 排除異常 ▼ Restart operation 再次啟動運轉
	Failing to supply water 無法供水時 (Failing to reach the full water level within 40 minutes or fail to reach the required level (10L) within 8 minutes 經過40分鐘還無法達至滿水位，或經過8分鐘還沒有達到規定水位 (10L) 時)	<ul style="list-style-type: none"> Is the tap turned on? 水龍頭是否打開？ Is the tap water pipe frozen or out of supply? 自來水管是否凍結或停水？ Is the filtering net at the water inlet blocked by contamination? 供水口濾網是否被污物堵塞？ 	 ▼ Troubleshooting 排除異常
	Failing to drain water 無法排水時 (Failing to drain up water within 5 minutes 經過5分鐘還無法排水完畢)	Check the water drainage hose 請對排水管進行檢查 <ul style="list-style-type: none"> Is the water drainage hose laid down? 排水管是否被放下？ Is the water drainage hose squeezed up? 排水管是否被壓扁？ Is the hanging height of the water drainage hose more than 1m? 排水管掛靠高度是否超過1m？ 	 ▼ ▼ Restart operation 再次啟動運轉
	Basket does not rotate 槽不能旋轉 (The basket is washing rinsing Rotating, sprinkling and washing Spinning, basket reverse stirring 槽旋轉洗衣·沖洗 旋轉噴淋洗衣 脫水，槽反轉攪拌)	<ul style="list-style-type: none"> Is the lid closed? 機蓋關閉沒有？ 	Restart operation 再次啟動運轉 CLOSE Restart operation 再次啟動運轉
	Stop during the spinning course 脫水過程中停止	<ul style="list-style-type: none"> Is the laundry laid aside? 衣物是否偏置於一側？ 	Please press the "START/PAUSE" button to pause the operation, rearrange the laundry evenly, and restart with the lid closed. 請按下暫停按鈕暫停運轉，調整衣物平衡後，關閉機蓋重新啟動。

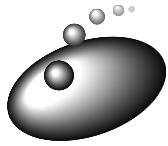

When Failure Happens (continued) 有故障發生時（續）

DISPLAY	Alarm content 警報內容	Part to check 檢查部位	Solution 處理方法
	The lid is not locked completely (The lid is not completely closed) 機蓋沒有完全鎖緊 (機蓋沒有完全關閉時)	<ul style="list-style-type: none"> Is there foreign substance under the lid? 機蓋下有異物？ 	Troubleshooting 排除異常 ▼ Restart operation 再次啟動運轉
	Washing basket can not rotate (washing, rinsing, spinning) 洗衣槽無法旋轉 (洗衣、沖洗、脫水)	<ul style="list-style-type: none"> Are the washings oblique? 衣物有無偏斜？ Or is the washing machine placed straight? See page 7 洗衣機是否水平放置？ 7 	Please press the "START/PAUSE" button to pause the operation, rearrange the laundry evenly, and restart with the lid closed. 請按下暫停按鈕暫停運轉，調整衣物平衡後，關閉機蓋重新啟動。
	Lock of lid can not be unlocked 機蓋緊鎖無法解除	<ul style="list-style-type: none"> Press "PAUSE" button, and then restart it. 按下暫停按鈕，然後重新開機。 	If there is still trouble, stop using the unit and contact authorized service centre. 若仍出錯，請停止使用並聯絡日立維修服務中心。
	Fail to spinning 無法脫水	<ul style="list-style-type: none"> Is the water drainage hose properly installed? 排水管是否被正確安裝？ Refer to the solution for when 「C2」 is displayed. 請參考指示燈出現「C2」時的處理方式。 Check whether there is excessive foaming. 是否產生大量泡沫。 Run a rinse operation before trying to spin again. 請先執行「沖洗」後再進行脫水。 	Troubleshooting 排除異常 ▼ Restart operation 再次啟動運轉

- If the above abnormal alarms occur, they may be caused by outside interference.
若出現上述之外的異常警報，有可能是由外來干擾導致。
- At that time, please press the PAUSE button to suspend the washing machine, then restart it. If the same alarms occur, please stop the use and contact authorized service centre.
此時請按下暫停按鈕暫停運轉，然後重新開機，若仍出現相同的異常警報，請停止使用並聯絡日立維修服務中心。

Before the repair request 要求修理前

Case 現象
Fail to running 不運轉

Please recheck the following items 請再次檢查以下項目

Cause 原因
<ul style="list-style-type: none"> Is power failure? 是否停電？ Does fuse or breaker blow? 保險絲或熔斷器是否燒斷？ Can the power plug enter the socket properly? 電源插頭是否可靠地插入電源插座？ Is the power switched on? 電源開關是否打開？ Is the tap turned on? 水龍頭是否打開？ Is the "Timer washing process" set? 44 是否設定了預校洗衣程序？ 44 Is the "START" button pressed or not? 有無按下啟動按鈕？

Case 現象	Cause 原因
Failure to supply water 不供水 No spinning, washing basket cannot rotate 不脫水、洗衣槽無法旋轉 No stirring 不攪拌	Please refer to "Part to check" in "About abnormality alarm". 53 請參照關於異常警報中的「檢查部位」。 53
Unable to air-jet dry 無法風乾	<ul style="list-style-type: none"> • Please refer to "The Approximate air-jet duration of laundry". 27 請參照衣物的大致風乾時間。 27
It does not work after setting of air-jet dry 設定風乾後無法工作	<ul style="list-style-type: none"> • if there is water remained in the dehydrating basket, Start button can not be pressed. And it can only be pressed after draining all of the water. 脫水槽中有水積存時，就不能按“啟動”鍵，要先進行排水，把水排光後再按“啟動”。
Cannot open the lid 機蓋打不開	<ul style="list-style-type: none"> • If there is outage and shutdown during the operation, the washing machine will generate alarms and cut off the power supply. The lid is still locked. When power supply is switched on again, the lid lock will be unlocked. 電源開關是否打開？ (運轉過程中出現斷電或停電時，洗衣機將發出異常警報並自動切斷電源，機蓋仍處於鎖定狀態。再次接通電源後，機蓋緊鎖將解除。)
Abnormal sound occurs 發出異常聲音	<ul style="list-style-type: none"> • Is the washing machine declining or shaky? 7 Installation Guide 洗衣機是否有傾斜或搖晃？ 7 安裝指南 • Is any barrette or metal item mixed in the washing basket? 有無髮夾或金屬物體混入洗衣槽內？
No buzz at the end of washing 洗衣結束後無蜂鳴聲	<ul style="list-style-type: none"> • Is the buzz at the end of washing set as cancelled? 46 是否已設定取消洗衣結束蜂鳴聲？ 46
The lid cannot be opened during the operation. 運轉過程中，機蓋無法打開	<ul style="list-style-type: none"> • The washing machine has been set the safety protection mode during the operation. If opening the lid, please press the "START/PAUSE" button. 16 本機在運轉過程中就已經設定了安全保護模式，如要打開機蓋請按“啟動/暫停”鍵。 16
Water leakage 漏水	<ul style="list-style-type: none"> • Is the tap of proper shape? 11 水龍頭的形狀是否合適？ 11 • Are the one touch joint and the connection nut unfastened? 11 便捷連接器和連接絲母是否出現鬆動？ 11
Water cannot be reserved 不能儲水 (when pouring the water with water basket) (用水桶等灌水)	<ul style="list-style-type: none"> • Is the power switched on? 電源開關接通了沒有？ (If the power supply is switched off or failed during drainage, the drainage valve will be in open position. After power on, valve closes.) (排水中途切斷電源或停電時，排水閥處於打開狀態。接通電源，閥關閉。)
The indication for Auto Self Clean disappears 自動筒清洗的顯示消失	<ul style="list-style-type: none"> • Can Auto Self Clean be set for the selected program? 是否選擇了不能設定自動筒清洗的程序？ • Is the function set to "no spin"? 是否設定為不脫水？ • If it has been set to "spin for 1 minute", "spin only" or "no spin" manually, the [Auto Self Clean] function will be released automatically. 手動設定為脫水1分鐘或僅脫水、不脫水的話，「自動筒清洗」功能會自動解除。
Cannot set Auto Self Clean 無法設定自動筒清洗	<ul style="list-style-type: none"> • Is the choice of Auto Self Clean program cannot be set automatically? 是否選擇了不能設定自動筒清洗的程序。
Auto Self Clean function setting, but no action 即便設定了自動筒清洗也不運作	<ul style="list-style-type: none"> • Is the washing one side imbalance? 洗衣物是否偏向一邊不平衡？

• Except the failures mentioned above, the lid lock protector may cause cases such as stopping during operation or lid being unable to be opened. In such a case, please unplug the power supply unit. Plug it back after 5 minutes, and then reset operation.
除了上述故障外，如發生運行中途停止或機蓋無法打開的現象，是機蓋緊鎖開關保護器動作。此時，請拔下電源插頭，五分鐘後再插上，重新設定並運行即可。

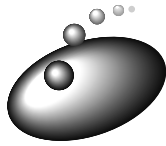

When Failure Happens (continued) 有故障發生時（續）

The following cases are not failures
以下現象並非故障

	Case 現象	Cause 原因
About the water supplying 關於供水	Supply water during the washing process. 洗衣過程中供水。	<ul style="list-style-type: none"> Supply water automatically if the water level drops during the washing process. 洗衣過程中若水位下降，便會自動補水。
	The water cannot be charged when starting washing form rinse. 從沖洗開始洗衣時，無法供水。	<ul style="list-style-type: none"> The rinse water can only be supplied after drainage and spinning. 排水和脫水之後才開始進沖洗用水。
	After connecting the water supply pipe, water will come in from the water inlet if turning on the tap. 供水管連接後，打開水龍頭，有水從供水口處流出。	<ul style="list-style-type: none"> With the application of decompression valve, it takes some time to close the valve. 由於採用了減壓閥，閥門關閉需要一定的時間。
	The pulsator stops rotating during the charging for about 1 minute. 供水過程中葉輪停止旋轉，供水停止約1分鐘。	<ul style="list-style-type: none"> It may be influenced by interference outside, and it takes some time for the sensor to detect the interference. 可能受到了外來干擾的影響，而傳感器檢測干擾需要一定時間。
	The rotary water supply takes a longer time. 旋轉供水時間變長。	<ul style="list-style-type: none"> As the water level of washing machine is too low. 這是由於洗衣機的供水量太小所引起的。
About the sound 關於聲音	Squeezing sound is heard when rotating washing - spinning basket by hand. 用手轉動洗衣·脫水槽時有“吱吱”聲。	<ul style="list-style-type: none"> This is the sound of balance ring which is used for reduce the shock during spinning. 為了減少脫水時的震動所用平衡環的聲音。
	When washing and basket rotation washing starts, clicking sound is heard when starts spinning. In addition, the clicking sound for stirring operation is heard before rearrangement of laundry. 洗衣啟動時 槽旋轉洗衣開始時 脫水開始時有“咔嚓”聲 攪拌動作時 抖開衣物動作前“卡，卡”的反轉聲。	<ul style="list-style-type: none"> That's the sound generated during modes switching by clutch. 是離合器進行模式切換的聲音。 (The volume differs according to time) (聲音的大小因時而異)
	Discontinued cracking sound from motor is heard during high speed rotation of spinning. 脫水的高速旋轉中有“卡拉卡拉”的這樣的聲音。 A whir sound will be heard during the washing process. A "kaka" sound will be heard after the dehydration. 洗衣過程中有“嗚嗚”聲。 脫水結束後有“卡卡卡”聲。	<ul style="list-style-type: none"> This is the sound generated from the connection part of motor and washing - spinning basket when the spinning rotation speed is under control. It will continuously generate from certain place when there is huge laundry load or there is oblique. 脫水旋轉速度控制時，電機與洗衣·脫水槽連接部位發出的聲音。由於衣物過多或偏置有時會連續在某個領域產生。 This is the sound generated by the reverse operation of impeller and spinning basket. This sound is produced by inertia rotation braking. 波輪與脫水槽反向運轉的聲音。 慣性旋轉制動產生的聲音。
About rinsing 關於沖洗	Water-storage rinsing can be turned into water-injection rinsing. 儲水沖洗可轉變為注水沖洗。	<ul style="list-style-type: none"> The safe switch works when the washing declines. 洗衣物偏置，安全開關起作用的緣故。 (The safe switch will work once after every 20 times spinning) (安全開關脫水20次左右動作一次)

Case 現象	Cause 原因
About rinsing 關於沖洗 <p>During rinsing, water-storage rinsing will automatically change to water-injection rinsing, and the rinsing time and spinning time will become longer. 沖洗過程中，由儲水沖洗自動變為注水沖洗，並且沖洗時間與脫水時間都變長。</p>	<ul style="list-style-type: none"> The detergent has caused too much foam, so the washing machine will automatically adjust. 這是由於使用的洗衣劑泡沫過多，造成洗衣機自動進行調整。
About the spinning 關於脫水 <p>Supply water during spinning. 脫水過程中供水。</p>	<ul style="list-style-type: none"> The security switch acts as the laundry declines. Change automatically to the "Water-storage rinse" for the next rinsing. 由於衣物偏斜導致安全開關動作的緣故。下次沖洗將自動變為儲水沖洗。
<p>Supply water and start rinsing during spinning. 脫水過程中開始供水並沖洗。</p>	<ul style="list-style-type: none"> The security switch acts as the laundry declines. Start spinning and agitating after rinsing, and the spinning will go on after clearing the laundry declination. 由於衣物偏斜導致安全開關動作的緣故。沖洗後進行脫水和攪拌運轉，消除衣物偏斜後還會繼續脫水。
<p>Spin intermittently after spinning starts. 脫水開始後，間歇性地脫水。</p>	<ul style="list-style-type: none"> It is because the sensor control the spinning times to improve the efficiency of spinning. 這是為提高脫水效率，由於傳感器控制脫水次數的緣故。
<p>The lid cannot be opened even when the PAUSE button is pressed during spinning. 脫水過程中，即使按下暫停按鈕也無法立即打開機蓋。</p>	<ul style="list-style-type: none"> When the power supply is cut off, the basket stops completely, and the lid lock will be unlocked. 當斷開電源，脫水槽完全停止下來後，機蓋緊鎖將被解除。
<p>The power supply switch will not work right away even when the ON/OFF button is pressed during spinning. 脫水過程中即使按下電源開關按鈕，電源開關也不會立即起作用。</p>	<ul style="list-style-type: none"> The power supply switch won't work until the basket stops the inertial rotation. 直到脫水槽的慣性旋轉停止後，電源開關才會起作用。
About the water level 關於水位 <p>Relatively low water level compared with the washings load. 水位相對於洗衣量較低。</p>	<ul style="list-style-type: none"> The setting of the water level is based on the extent of the laundry emerging out the water surface and the ability of the clothes volling up and down in the washing tub. 洗衣機以衣物稍微露出水面為依據設定水位，由葉輪攪拌衣物可以上下翻動。 Since the clothes of chemical fiber is comparatively light, the water level is set accordingly low. 由於化學纖維、聚脂纖維等衣物較輕，因此水位設定也較低。
<p>Relatively high water level compared with the washings load. 水位相對於洗衣量較高。</p>	<ul style="list-style-type: none"> The water level will rise during washing if the clothes being washed have been drenched or water has been charged in advance. 洗衣已濕透的衣物或洗衣槽中事先放了水時，洗衣時水位會較高。
<p>Midway water drainage during washing. 洗衣的中途排水。</p>	<ul style="list-style-type: none"> It will start operation when there is still accumulated water. To prevent water splashing due to too much water, it may sometimes drain water. 在積水的狀態下開始運轉時，為了防止水量過多而飛濺，有時會排水。
About the lint filter 關於棉絮過濾器 <p>There is much floss. 棉絮較多時</p>	<ul style="list-style-type: none"> If there is much floss in "NORMAL" process, the efficiency of the floss filtering can be improved by increasing the water consumption, extending washing time and setting rinse for more times. 標準程序中出現較多棉絮時，可用提高水位，延長洗衣時間和設定多次沖洗等方法提高過濾棉絮的效率。

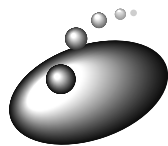

When Failure Happens (continued) 有故障發生時（續）

Case 現象	Cause 原因
About the washing duration 關於洗衣時間	<ul style="list-style-type: none"> • The washing time may exceed predefined time in case of extremely small amount of charged water. 供水量很少的情況下，洗衣時間有可能超過設定時間。 • Correct the remaining duration according to water supply. 按照供水狀態，修正殘留時間。
About the air jet duration 關於風乾時間	<ul style="list-style-type: none"> • The preset time is the time for spinning, and the actual operation time includes the time of clothes rearrangement and clothes balancing, which, will be longer than the preset time by 5~30 minutes. 設定時間是進行風乾脫水的時間，實際運轉時間還要加上理順衣物和糾正衣物偏斜的時間，大概比設定時間延長5至30分鐘。
About the Inhaling processing 關於風乾程度	<ul style="list-style-type: none"> • It is not dried. 未乾。 • Depending on the amount & types of laundries, air temperature & moisture, seasons and environment, the completion time may differ. 由衣物的數量・種類，氣溫・濕度，季節和環境決定，完成時間會變化。 • Please refer to "Approximate air-jet duration". 請參照大致的風乾時間表。
About the power switch 關於電源開關	<ul style="list-style-type: none"> • The power supply switch may not work right away when switching from "OFF" to "ON". 電源開關由“斷開”轉換到“接通”時，可能不會立即起作用。 • The indicating LED won't light right away when the power supply switch is switched on. 電源開關“接通”後，指示燈不會立即點亮。 • Ten processes LEDs light after the power supply switch is switched off. 電源開關“斷開”後，10個程序指示燈點亮。
About the lid lock 關於機蓋緊鎖	<ul style="list-style-type: none"> • The lid cannot be opened even when the PAUSE button is pressed during the spinning. 脫水過程中，即使按下暫停按鈕也無法立即打開機蓋。 • After the power supply is cut off, the spinning basket stops completely, and the lid lock will be unlocked. 當斷開電源，脫水槽完全停止後，機蓋緊鎖將被解除。
Others 其他	<ul style="list-style-type: none"> • Water comes out from the water drainage hose during first time usage. 第一次使用時，有水從排水管中流出。 • Pulsator rotates but does not display the washings load and water quantity after pressing the START button. 按下啟動按鈕後，葉輪轉動但沒有顯示洗衣量和水位。 • This is the water remains in the drainage hose during tests in the factory. 這是工廠做性能測試時剩下的水。 • This is because the sensor cannot detect successfully. Power supply can be cut off and the washing machine will be restarted. 這是由於外來干擾的影響而導致傳感器無法正確檢測造成的。此時可切斷電源，然後再次啟動。

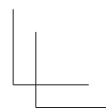
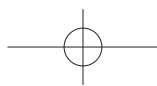



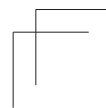
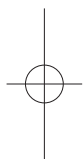

備忘録

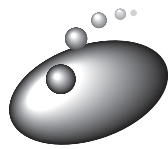
Lined area for notes with horizontal ruling lines.



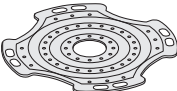

Optional Parts 另售部件

<p>■ Extended water supply hose 延長用供水管 (1m/2m/3m)</p> <ul style="list-style-type: none"> For supply hose extension. 用於延長供水管。 	<p>■ Washing cap 洗衣蓋</p> 	<p>■ Lint filter 棉絮過濾器</p> 
<p>■ Extended water drainage hose (about 80 cm) 延長用排水管 (約 80 cm) (BW-V80FS)</p> <ul style="list-style-type: none"> For drainage hose extension. 用於延長排水管。 	<p>■ Water Drainage Hose 排水管(BW-V80FSP)</p> 	<p>■ Fixing holder of water drainage hose 排水管固定架(BW-V80FSP)</p> 

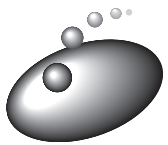

Product Specifications 產品規格

Model 型號	BW-V80FSP	BW-V80FS
Type 種類	Fully automatic washing machine 全自動洗衣機	
Power 電源	220V~, 50HZ	
Normal washing capacity 標準洗衣容量	8.0kg (The quality of dry clothes) (乾布的質量)	
Normal spinning capacity 標準脫水容量		
Normal water level 標準水位	58L ("NORMAL" program) 58L (「標準」程序)	
Rated power 額定功率	Washing: 440W; Spinning: 160W 洗滌時：440W；脫水時：160W	
Washing mode 洗衣方式	Automatic reverse pulsator type 自動正反攪拌方式	
Pressure of tap water 自來水水壓	0.03MPa~0.8MPa (0.3kgf/cm ² ~8kgf/cm ²)	
Dimension 外形尺寸	W 547mmxD 600mmxH 1005mm 寬 547mmx深 600mmx高 1005mm	W 577mmxD 586mmxH 1005mm 寬 577mmx深 586mmx高 1005mm
Weight 重量	About 36kg 約 36kg	