

Instruction Manual

HITACHI
Inspire the Next

Washing Machine

Front Loading

Model

BD-90XFV
BD-80XFV

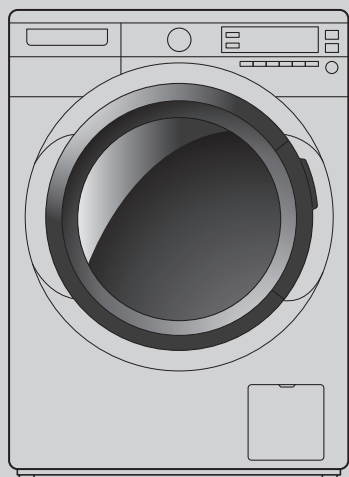

Thank you for purchasing a Hitachi front loading washing machine.

- Please read this Instruction Manual carefully for proper operation of the machine.
- Please keep this Instruction Manual for future reference.

Contents

Preparation for use

Environmentally Friendly Waste Disposal	3
Hints and Tips for Eco-friendly Washing	3
Safety Instructions	3
■ Installation	4
Parts and Accessories	6
Control Panel and Display	7
Before You Start Washing	9

Operation

How to Use the Washing Machine	11
Program Overview	16
In Case of Emergency	18

Maintenance

Care and Maintenance	18
Troubleshooting	21
Error Codes	24
How to Install the Washing Machine	25
Customer Service	30
Consumption Values	31
Specifications	31

For household use only

Environmentally Friendly Waste Disposal

Disposing of the packaging

The shipping package has protected your new washing machine on its way to your home. All materials are ecologically harmless and recyclable. Please contribute to a better environment by disposing of packaging materials in an environmentally conscious manner.

Ask your dealer about current means of disposal.

Risk of choking!

Do not let children play with packaging and associated parts.

Risk of choking on plastic film and collapsible boxes.

Disposing of your old appliance

Old appliances are not worthless rubbish. Environment-conscious recycling can reclaim them to valuable new materials.

Risk of death!

Unplug mains plug on redundant appliances. Cut off mains cable and discard with mains plug.

Destroy the lock on the door. To prevent playing children from being trapped and endangered, ensure that the door locking mechanism is disabled.

If you wish to discard this product, please contact your local authorities or dealer and ask for the correct method of disposal.

Hints and Tips for Eco-friendly Washing

- Keep to the load limit of each program.
 - Your washing machine automatically adjusts the operating time and amount of water of each program depending on the load.
 - You only need to use the Prewash or Intensive options if your laundry is heavily soiled.
 - Add detergent according to the degree of soiling, laundry size and water hardness, and follow the detergent manufacturer's instructions.
 - Using the Cotton program with water temperature at 60°C setting instead of the Cotton program with water temperature at 90°C will save energy, and will remove ordinary stains. Better still, in areas where the temperature is high, you can remove ordinary stains without using hot water by setting 'Cold' programs for more economically friendly operation.
-

Safety Instructions

This washing machine is designed for home use only.

Before operating the washing machine, please read these safety instructions carefully.

- This appliance is intended to be used in household and similar applications such as: (IEC 60335-2-7)
 - staff kitchen areas in shops, offices and other working environments;
 - farm houses;
 - by clients in hotels, motels and other residential type environments;
 - bed and breakfast type environments;
 - areas for communal use in blocks of flats or in laundrettes.

Safety Instructions

WARNING

Issues which could cause death or serious injury.

General safety

- Do not dismantle, repair or modify the appliance.
→ This could cause malfunction, fire, electric shock or injury.
→ For repair, please contact your local service center.
- Do not put fire sources or anything inflammable in or near the washing machine (gas, diesel, petrol, thinner, alcohol or clothes stained with these substances).
→ This could cause an explosion or fire.
- Do not pour water on the machine when it is running.
→ This could cause an electric shock.
- Do not climb on the washing machine.
→ This may cause injury.
- Do not put heavy objects on the washing machine.
→ This may damage the surface of the worktop.
- It is a malfunction if the drum is still rotating when the door is open. In this case never touch the drum nor laundry inside and stop using the washing machine immediately, and contact your local service center for repair.
- This appliance is not intended for use by persons (including children) with reduced physical, sensory or mental capabilities, or lack of experience and knowledge, unless they have been given supervision or instruction on how to use the appliance safely.

Installation

- The installation of the appliance should be done by the manufacturer's dealer or service agent.
→ If the installation, test run and inspection of the appliance are not carried out following the installation method outlined in these instructions, the manufacturer is not liable for any accident or damage caused.
- Do not install in a damp place such as a bathroom or a place exposed to rain.
→ Risk of fire, electric shock, current leakage or product damage.
- Do not install on a board with castors or an unstable surface.
→ This may cause injury or malfunction vibration due to abnormal vibration.
- Do not use a plug adapter to convert 3 pins to 2 pins. (The washing machine must be grounded)
→ This could cause an electric shock.
- The opening must not be obstructed by carpeting when the washing machine is installed on a carpet floor.
- If the washing machine is to be connected to the water mains, please use new water supply hose.

Power source and cord

- Do not insert the plug with a wet hand.
→ This could cause an electric shock.
- Use the rated mains voltage and do not connect another plug at the same socket.
→ Using the washing machine plug together with other electrical systems may cause overheating in the plug and result in fire.
- When removing the worktop to install the washing machine under a counter, use a separately sold upper plate. (Part No. BD-W80MV 150)
- Clean off all the dust on the plug.
→ A dirty or dusty plug may cause a fire.
- Do not use an electric socket or connection which is damaged or loose.
→ This could cause an electric shock or a short circuit which may start fire.
- Do not mark, cut, modify, bend or fold the power cable.
→ A damaged power cable could cause fire or an electric shock.
- Do not use a mains plug adaptor or an extension cable.
→ This could cause overheating which may cause a fire.
- If the power supply plug is damaged, it must only be replaced by the authorized service agent or repairing shops appointed by the manufacturer in order to avoid a hazard.

Safety Instructions

Child safety

- Keep packaging out of reach of children and babies.
→ Danger of suffocation.
- Do not let children climb onto the washing machine or open the drum door, and do not leave a box or chair near the washing machine which could enable children to climb onto it.
→ This may cause injury.
- Children should be supervised to ensure that they do not play with the appliance.

CAUTION

Issues which could cause injury or damage your belongings

General safety

- If there is a water outage or you remove the water supply hose and reattach it, turn off the tap and press the Start/Pause button, then turn on the tap slowly after 40 seconds.
→ Air pressure could damage the washing machine if there is a lot of air in the water pipe.
- Regularly check to confirm that the union nut of the water supply hose is tightened.
→ A loose nut may cause a water leak.
- Remove the plug from the socket and turn off the water tap if you don't use the machine for a long time.

Use

- All transport bolts must be removed before using the washing machine.
→ They may cause abnormal vibration or failure.
- Check inside the drum before washing.
→ Make sure that small pets do not climb into the drum.
- Do not wash waterproof items such as raincoats, wet suits, ski suits, sleeping bags, cushions, pillows, shoes, etc.
→ The washing machine may not work properly, or the items may cause injury or damage the machine.
- Do not operate without the detergent dispenser.
- Do not use tap water hotter than 50°C.
- Do not wash items together with coins, pins or stones.
→ This may damage clothes and the washing machine, and cause a water leak. Check inside pockets before washing.
- Do not press the buttons with sharp or pointed objects.
- Be careful when draining hot water.
- Do not lean on or put weight on the opened door of the washing machine.
→ This may cause damage to the washing machine.
- Do not attempt to open the door while it is operating.
- Do not put heavy objects, liquid-filled containers or equipment which produces heat (e.g. oven, rice cooker, etc.) on the washing machine.
→ This may damage the washing machine or the surface of the worktop.



Care and maintenance

- If detergent, fabric softener or bleach spills on the surface of the machine, clean it up with a damp cloth immediately.
→ The plastic or steel parts of the washing machine may be damaged.
- Do not place heat sources near the washing machine.
→ This may cause deformation of the machine.

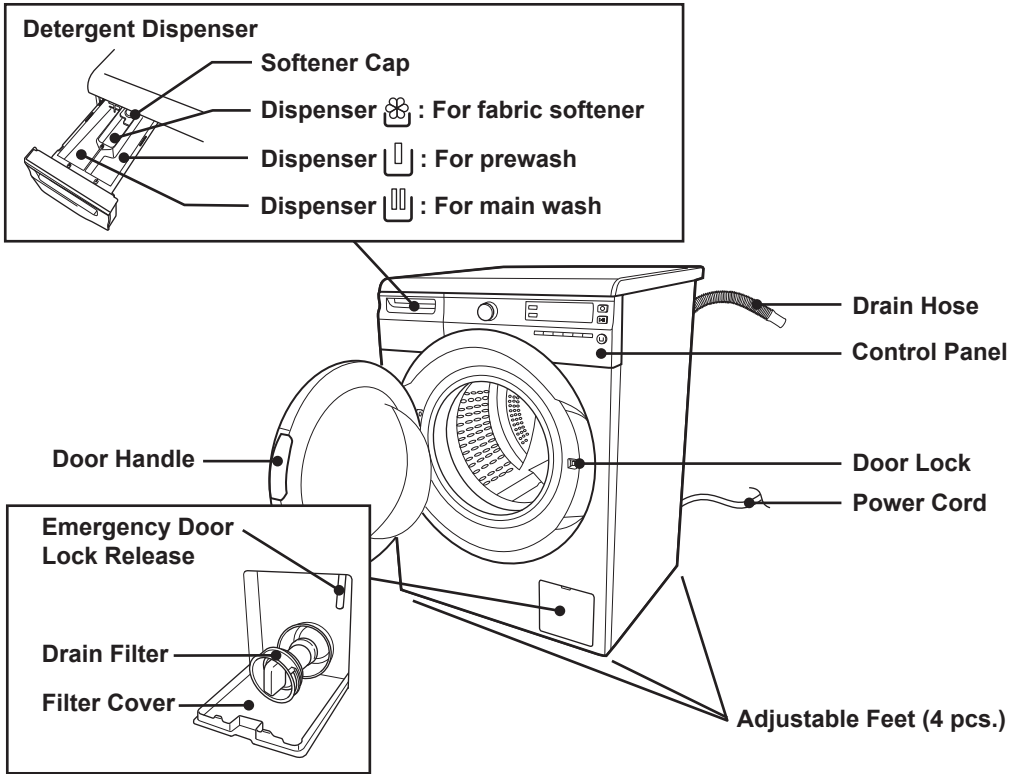
Parts and Accessories

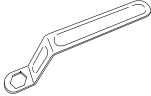
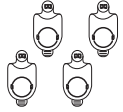
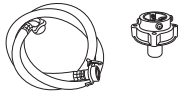

Packed-In Accessories

Either type of water supply hose is packed in by the demand of different area.		Hose Guide	Spanner	Cover Caps
Water Supply Hose & One-touch Joint	Water Supply Hose (Screw Type)			
		(1 piece)	(1 piece)	(4 pieces)

Optional Accessories

Upper Plate



See page 29
Part No. BD-W80MV 150

Please contact your local dealer when installing the upper plate and the water leak detection hose.

Control Panel and Display

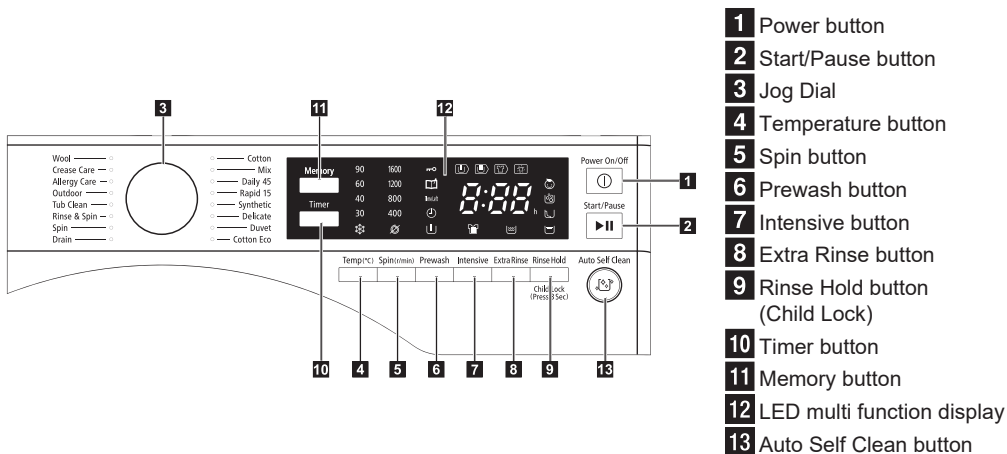

1 Power button	Press this button to switch power on and off. If no program is selected or no button is pressed for 10 minutes, the washing machine automatically switches itself off.
2 Start/Pause button	Press this button to start or pause a program. When the machine is paused for over 1 hour, the washing machine automatically switches itself off.
3 Jog Dial	Turn this dial to select wash programs.
4 Temperature button	Enables temperature setting from cold up to 90°C. When you select cold, the ❄️ symbol is shown on the display and the heater switches off.
5 Spin button	Enables spin speed setting from 0 (No Spin) to Maximum. <ul style="list-style-type: none"> ⊘ (No spin) Spin is cancelled, and the water is drained out only. Recommended for delicate fabrics.
6 Prewash button	Prewashes heavily soiled items before the main wash. The 🧼 symbol is shown on the display. Pour the powdered detergent into the dispenser 🧺.
7 Intensive button	Extends the washing time for more thorough washing. The 🕒 symbol is shown on the display.
8 Extra Rinse button	Increase the number of rinses for washing. Recommended for areas with very hard water, when washing baby linen, and for people concerning about detergent residue. The 🚿 symbol is shown on the display.
9 Rinse Hold button (Child Lock)	Laundry remains in the last rinse water without progressing to the final spin cycle to prevent the clothes from wrinkling. To unload, select the Spin or Drain program. The 🚿 symbol is shown on the display. <div style="border: 1px solid black; padding: 5px; margin-top: 10px;"> <p>Child lock: To prevent accidental operation by children, this disables the operation buttons and dial, and also locks the door. Press the Rinse Hold button for 3 seconds to activate this option. The 🚿 symbol is shown on the display. Press Rinse Hold button for 3 seconds again to cancel the child lock.</p> </div>
10 Timer button	Let you program a wash to finish up to 24 hours later. The 🕒 symbol is shown on the display.

Control Panel and Display







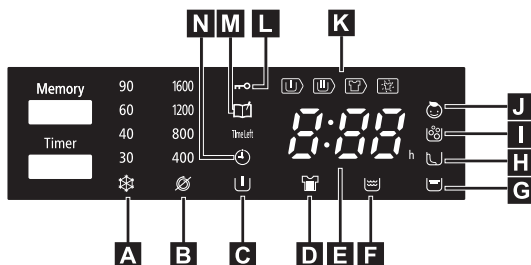

11 Memory button

Allows you to store a customized wash cycle which you use frequently. The  symbol is shown on the display.

12 LED multi function display

Displays all cycle information, remaining time and error codes.



- A** Water temperature
The  symbol is on when the heater is off (Cold setting).
- B** Spin speed
 (No Spin) : Spin is cancelled and rinsed water is drained in Rinse process only.
- C** Prewash option
- D** Intensive option
- E** Remaining time of the program (shows 'Time Left'), remaining time until timer operation is completed (shows 'h'), and error codes.
→ Page 24 : Error Codes
- F** Extra Rinse option
- G** Rinse Hold option
Final spin is cancelled and water is not drained, so the laundry remains in the last rinse water.
- H** Imbalance in the drum.
→ Page 9 : Control Panel and Display.
- I** Excessive foam in the drum.
→ Page 9 : Control Panel and Display.
- J** Child Lock option
All buttons are disabled except the Power button and Jog Dial, and the door is locked when the  symbol is on.
- K** Progress indicator
Shows which phase of the program is operating.
The following symbols blink while each phase is running, and go off as each phase ends.
 -  Prewash
 -  Main Wash
 -  Rinse
 -  Spin
- L** Door lock
The door is locked when the  symbol is on.
- M** Memory option
- N** Timer option

Control Panel and Display

The following symbols are displayed when washing time is prolonged due to :



- Excessive foam in the drum.
→ Pouring in extra water to remove excessive foam.



The symbol on the left lights.

- Imbalance in the drum.
→ Correcting imbalance by rotating the drum.



The symbol on the left lights.

***This is not a malfunction.** Remaining time may be turned back when these symbols are displayed so that operation is completed in a longer time than the remaining time displayed at the start.

13 Auto Self Clean button

Automatically cleans the outside of the tub and the inside of the outer tub to keep the washing machine clean. The setting is switched off at the time of shipment from the factory. Once it is switched on, the Auto Self Clean function operates every time you do your laundry.

Before You Start Washing

Preparation of the washing

- Remove any foreign objects (coins, safety pins, etc.).
- Use a washing net when you wash delicate clothes (knit products, lingerie, etc.).
- Zip up and brush sand out of pockets and collars.
- Brush pet hair out of laundries.

Before You Start Washing

Sorting of the laundry

- Sort the laundry according to the type of fabric and care label symbol (cottons, mixed fibers, synthetics, wool, hand wash, etc.).
- Do not wash too small amount of laundry such as only a pair of jeans.
→ This may result in insufficient spin performance.
- Separate colored and white items.

Risk of injury!

Washing the following items may cause injury or malfunction due to abnormal vibration :

- Waterproof items such as a wet suit, ski suit, etc.
 - Anti-slip treated items with rubber bottoms such as a doormat.
 - Cushions, pillows, shoes, etc.
-

Detergents and additives

- Use the amount of detergent recommended on the detergent package. The type and amount of detergent depends on the type of fabric, load size, degree of soiling and hardness of the water used.
Use less detergent if :
 - you wash a small load.
 - the laundry is slightly soiled.
 - Too much detergent can result in excess foam formation which reduces rinse efficiency or may cause a water leak.
 - Depending on the detergent brand, detergent may remain undissolved when the water pressure is low, or when the water temperature is low.
→ Page 20 : Care and Maintenance (Cleaning the detergent dispenser).
 - Do not use liquid detergent when using the Prewash option.
 - The detergent and any additives must be poured into the appropriate dispenser.
→ Page 6 : Parts and Accessories (Detergent Dispenser).
 - Pour in the detergent before you press the Start/Pause button. If you add the Prewash option, pour detergent into both dispensers () before starting.
 - For dyeing and bleaching, use dyes and bleaches that are suitable for washing machines.
 - For water softener and limescale removal agents, follow the instructions on the package.
-

Washing with different degrees of soiling

- Lightly to normally soiled : No washing options (Prewash / Intensive) are necessary for more eco-friendly operation.
- Normally to heavily soiled : Select Intensive as an option for better washing results.
- Heavily soiled : Select Prewash as an option for better washing results.

How to Use the Washing Machine

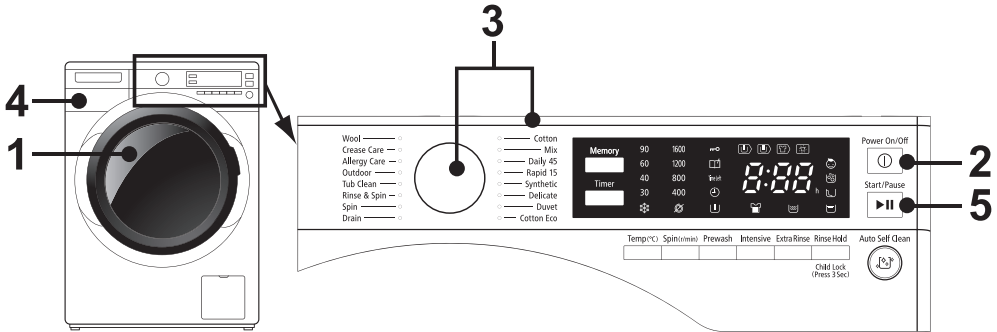

1 Sort and load the laundry

- Sort the laundry according to type of fabric, care label symbol, color and degree of soiling.
→ Page 9 : Preparation of the washing.
- Do not exceed the maximum load.
- Close the door. Take care not to trap any items of clothing between the door and rubber seal.

2 Press the Power button to switch power on

- If no program is selected or no button is pressed for 10 minutes, the washing machine automatically switches itself off. Press the Power button again to turn power on.

3 Select and adjust the program

- Select a washing program first with the Jog Dial.
- The duration of the selected program is shown on the display as a guide. Actual washing time may vary depending on the conditions.
- Use the option buttons to set additional functions.
→ Page 7 : Control Panel and Display.
→ Page 16 : Program Overview.
- If you select the wrong program by mistake, reselect the washing program by turning the Jog Dial.
- When the Cotton program is selected, settings such as spin speed, additional options, etc., are memorized. Same settings can be used when the Cotton program is selected again.

4 Add detergent into the detergent dispenser

- The detergent and any additives must be placed in the appropriate dispenser.
→ Page 6 : Parts and Accessories (Detergent Dispenser).
- Add the appropriate amount of detergent suggested in the manufacturers' instructions.
→ Page 10 : Detergent and additives.

How to Use the Washing Machine

5 Press the Start/Pause button

- The washing machine starts to detect laundry size, fabric type and water temperature before setting the wash time.
- The wash time displayed on the remaining time indicator varies according to the conditions.
- Page 7 : Control Panel and Display.
- Once a program starts, settings cannot be changed except for the spin speed setting of programs other than the Cotton/Daily 45/Rapid 15/Cotton Eco/Wool/Crease care/Rinse & Spin/Spin programs.

Pausing a program.	Press the Start/Pause button. The washing machine switches itself off if it is not restarted within 1 hour. Switch the power on and the program starts again from the beginning.
Adding clothes part way through a wash.	Press the Start/Pause button to pause the selected program. The door lock is automatically released after about 5 seconds when the water level and temperature are safe. You can then open the door and add your clothes. Close the door and press the Start/Pause button again to restart the program. * Note: It is not recommended to add a large amount of clothes as the washing machine first measures the load size to determine optimum operation.
Terminating a program.	Press the Start/Pause button, and press the Power button to switch power off. Then press the Power button again and select the Spin or Drain program to drain remaining water in the drum and spin-dry the laundry.

6 Program ends

- The buzzer sounds when the program ends.

By pressing the Spin button for 3 seconds, (After press Power button) the buzzer sound is deactivated. By pressing the Spin button again, the buzzer sound is reactivated.

- The washing machine automatically switches itself off when the program ends.

How to Use the Washing Machine

How to use the Auto Self Clean function

- 1 Press the Power button to turn on the power.
- 2 Select a program.
- 3 Press the Auto Self Clean button, and then press the Start/Pause button.

- The setting is switched off at the time of shipment from the factory. Once it is switched on, the Auto Self Clean function operates every time you do your laundry.
- Prior to the final spin cycle, the outside of the tub, and the inside of the outer tub are washed to eliminate dirt and mold.
- To deactivate the Auto Self Clean function, press the Auto Self Clean button again while the power is on.

- The Auto Self Clean function runs just before the spin cycle begins in each program.
- The Auto Self Clean function cannot be set or cancelled while the washing machine is operating.
- The Auto Self Clean function is automatically cancelled when:
 - Rinse Hold is set.
 - No spinning is set.
- Depending on the type and degree of dirt, some dirt may not be removed by using the Auto Self Clean function.
- If the washing machine is seldom used, some dirt may not be removed by using the Auto Self Clean function.
- To clean the tub more completely, we recommend using the Tub Clean program along with the Auto Self Clean function.

- The Auto Self Clean function is deactivated if one of the following programs is selected.
 - Duvet
 - Rapid 15
 - Wool
 - Daily 45
 - Tub Clean
 - Spin
 - Drain

How to Use the Washing Machine

How to use the Memory function

- 1 Press the Power button to turn on the power.
- 2 Select and adjust the program as desired.
- 3 Press the Memory button for 3 seconds, then the setting is memorized.
- 4 Press the Start/Pause button.

■ Once the setting is saved, the customized program can be selected with just a press of the Memory button.

■ Customized program can be changed by doing the same procedure.

How to use the Duvet program

Note

– Do not use blanket net. This may cause excessive vibration when spinning.

- 1 Load the laundry :

■ Fold a large item such as a duvet or blanket as follows.

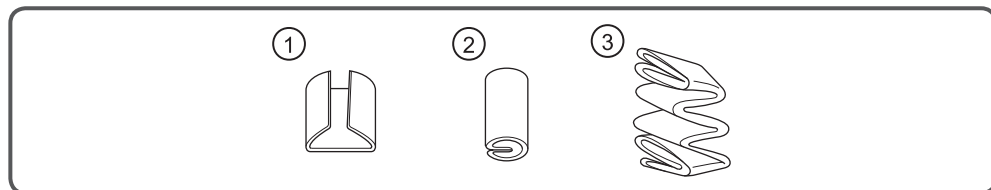

■ Load laundry into the drum with the ends facing the rear of the drum.

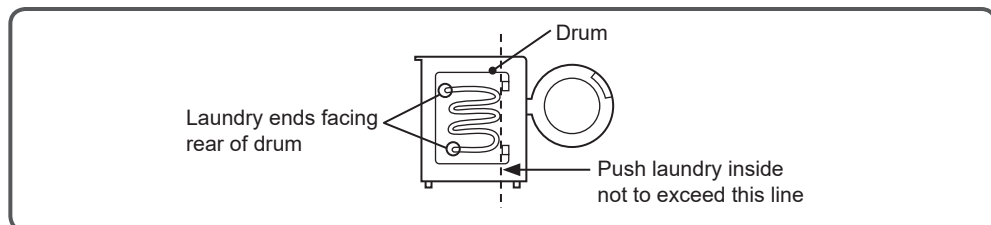

- 2 Press the Power button to switch power on.
- 3 Select the Duvet program.
- 4 Add detergent into the detergent dispenser.
- 5 Press the Start/Pause button.

Washable Items with the Duvet program :

● Washable Duvets

Machine washable duvets stuffed with not more than 1 kg of down or synthetic material (polyester).

- Do not wash duvets stuffed with wool or duvets with a silk covering.
- Do not add other items in the same wash.

● Washable Blankets

Synthetic blankets weighing not more than 2.5 kg.

- Do not wash pure woolen, long pile or electric blankets.

● Other Items

Bed pads and curtains weighing not more than 2.5 kg.

How to Use the Washing Machine

How to use the Tub Clean program

■ Use this program separately from any washing program.

- 1 Press the Power button to switch power on.
- 2 Select the Tub Clean program.
- 3 Press the Start/Pause button.
- 4 The Remaining Time indicator shows '- -' and starts blinking, and stops blinking after 1-2 minutes. Then press the Start/Pause button to pause the program.
- 5 Open the door and add the tub cleaner directly to the drum. Do not use detergent for washing clothes.
- 6 Close the door and press the Start/Pause button to restart the program.

Eco-friendly operation

Your washing machine features Intelligent Sensor Systems that detect laundry size, fabric type and water temperature, and then control the method of washing to maximize energy and water saving.

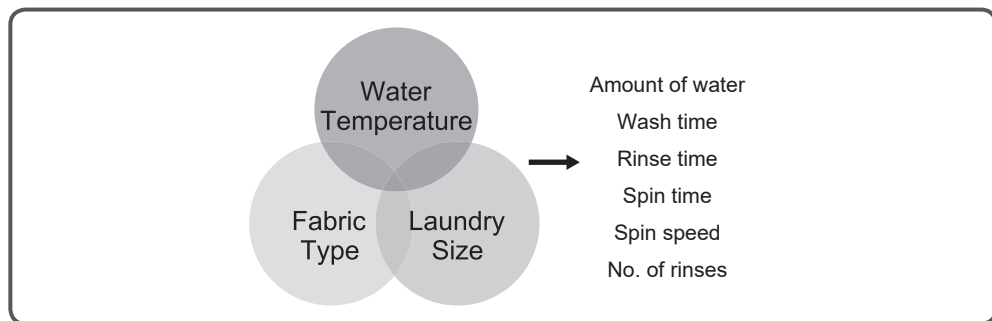

When the Cotton course with the Cold water setting (❄️ symbol is shown on the display) is selected, after laundry size, fabric type and water temperature are detected, the optimum amount of water, wash/rinse/spin times, spin speed and number of rinses are determined for eco-friendly operation.



Program Overview

Program	Type of Laundry / Notes	Model / Max Load	
		90XFV	80XFV
Cotton	For daily washing of cotton and linen items such as shirts, underwear, towels, bed linen and table linen.	9 kg	8 kg
Cotton Eco	For cotton and linen items. Eco operation that saves energy and water that provides the same washing performance as the Cotton program.	9 kg	8 kg
Rapid 15	This lets you wash small loads of lightly soiled clothes and small items such as underwear in 15 minutes. It's also ideal for freshening up just-worn clothes.	2 kg	2 kg
Synthetic	For washing normally soiled blouses, shirts, etc. made of polyester, acrylic or blends with cotton.	4.5 kg	4 kg
Mix	Lightly soiled items can be washed together with different types of laundry.	4.5 kg	4 kg
Delicate	Gentle wash program for delicate items such as lingerie and thin lace curtains.	4.5 kg	4 kg
Outdoor	For washing heavily soiled durable clothes (jeans, sportswear, etc.)	4.5 kg	4 kg
Duvet	For washable large items such as duvets, blankets, bedspreads, etc.	2.5 kg	2.5 kg
Wool	Gentle washing for machine washable woolens bearing.	2 kg	2 kg
Allergy Care	Removes allergens such as house dust mites, mold and bacteria. This program is tested and approved by Allergy UK.	4 kg	4 kg
Daily 45	For washing lightly soiled items in just 45 minutes.	6 kg	6 kg
Rinse & Spin	For rinsing and spin-drying only, recommended for hand washed items.	9 kg	8 kg
Spin	Use to spin-dry hand washed items, or after using Rinse Hold.	9 kg	8 kg
Drain	For emptying out water remaining after the last rinse when using a program with the Rinse Hold option.	-	-
Tub Clean	A special cycle that cleans the inside of the washing machine. Using this cycle regularly keeps the tub clean and prevents the growth of mold.	-	-
Crease Care	Gentle spin and increased water for easily wrinkled fabrics.	4.5 kg	4 kg

Cotton Eco program cycle is the recommended program cycle for a normal soiled load at the rated capacity.

Temperature Setting	Spin Setting	Selectable Options					
		 Prewash	 Intensive	 Extra Rinse	 Rinse Hold	 Timer	Auto Self Clean
☼/30-90°C	400-1600r/min, No Spin	○	○	○	○	○	○
30-60°C	400-1600r/min, No Spin	○	○	○	○	○	○
☼/30°C	400-800r/min, No Spin	-	-	-	○	-	-
☼/30-60°C	400-1200r/min, No Spin	○	○	○	○	○	○
☼/30-60°C	400-1200r/min, No Spin	○	○	○	○	○	○
☼/30°C/40°C	400-800r/min, No Spin	-	-	○	○	○	○
40-90°C	400-1600r/min, No Spin	○	○	○	○	○	○
☼/30°C/40°C	400-800r/min, No Spin	-	-	○	○	○	-
☼/30°C	400r/min, No Spin	-	-	○	○	○	-
90°C	400-1600r/min, No Spin	○	○	○	○	○	○
☼/30-60°C	400-1200r/min, No Spin	-	-	-	○	-	-
-	400-1600r/min, No Spin	-	-	○	○	-	○
-	400-1600r/min,	-	-	-	-	-	-
-	-	-	-	-	-	-	-
40°C	800r/min	-	-	-	-	-	-
☼/30-60°C	400-800r/min, No Spin	○	○	○	○	○	○



The Allergy Care program was awarded the Seal of Approval by Allergy UK. By reducing mold, house dust mites and bacteria, this program provides worry-free washing for people with delicate skin and families with a baby. The Allergy Care program was tested and approved under the following settings :
Washing temperature from 75°C to 90°C / No options added

In Case of Emergency

In the event of a power outage

The washing machine features a Fully Auto Restart function.

If the power is shut off part way through a wash, the cycle (wash/rinse/spin) at the time is memorized, and when power is restored, the same cycle automatically restarts from the beginning.

Emergency door release

If the laundry has to be removed in the event of an extended power outage, or in the event of malfunction of the door lock, the washing machine door can be opened as follows :

- 1 Press the Power button to switch power off (when the power is on in the event of malfunction of the door lock), and disconnect the mains plug.
- 2 Drain the water in the drum from the drain tube.
→ See page 19 : Care and Maintenance (Cleaning the drain filter).
- 3 Pull the emergency release downwards. The washing machine door can be opened and the laundry can be taken out from the drum.

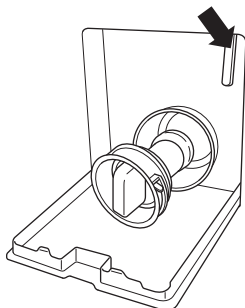

⚠ Risk of injury!

Hot water may come out from the drain tube.

Care and Maintenance

Cleaning the Door bellow

- 1 Remove foreign objects such as coin or pins.

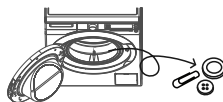

- 2 Clean inside the Door bellow with a dry cloth in left-right direction.

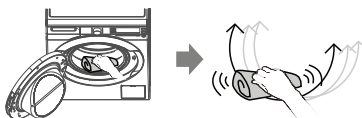

⚠ Caution

Do not apply too much force during door bellow cleaning because it may cause of door bellow take out and the water leakage problem.

Care and Maintenance

Cleaning the drain filter

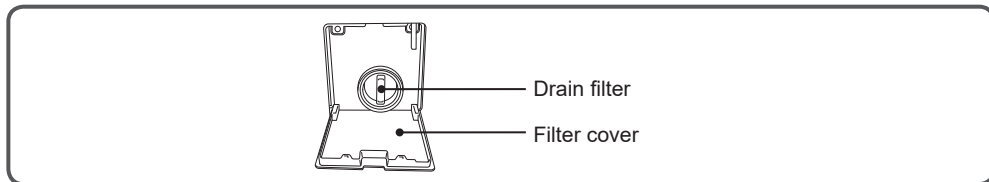

Risk of injury!

Hot water may come out from the drain tube and drain filter.

- Do not open the drain filter when a program is running.
- Do not clean the drain filter just after a program using hot water.
- Do not operate the washing machine without the drain filter.

- 1 Select the Drain program and start to drain remaining water in the drum. Make sure to drain the water first, otherwise a lot of hot water may come out.
- 2 Insert a thin/slim object such as a flat-blade screwdriver, handle of spoon/fork into the slot of the filter cover and open it.

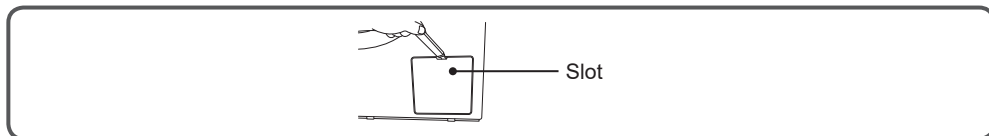

- 3 Place a piece of cloth under the filter cover. Turn the drain filter anticlockwise slowly and remove it. Make sure to open the drain filter slowly as hot water may come out.

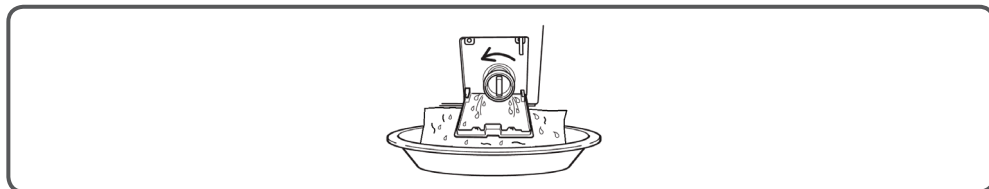

- 4 Remove foreign objects such as coins or pins. Clean inside the drain filter and the drain pump with a brush.

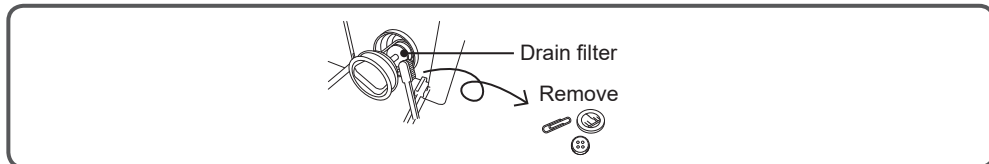

- 5 Return the cap, drain filter and the filter cover in reverse order.

Care and Maintenance

Cleaning the detergent dispenser

- 1 Remove the detergent dispenser.

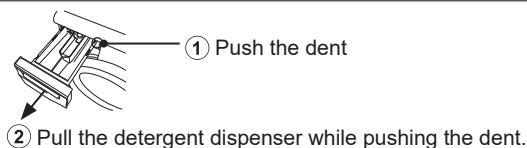

- 2 Remove dirt or detergent remaining in the detergent dispenser casing with a brush.

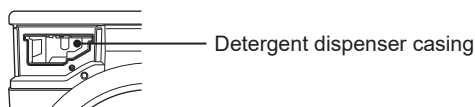

- 3 Wash the detergent dispenser with water. Use a brush for narrow parts or parts from which it is difficult to remove dirt.

■ How to remove and set the softener cap.

Pull up to remove

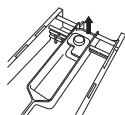

Push down firmly to set

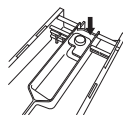

Cleaning the water inlet filter

- 1 Turn off the tap.
- 2 Remove the water supply hose from the rear panel of the washing machine.
- 3 Remove the water inlet filter and clean with a brush.

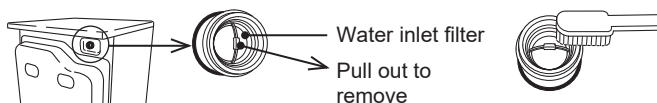

- 4 Return the water inlet filter and the water supply hose to their original positions.

Maintenance of the washing machine

■ External cleaning

Clean the surface of the washing machine with a soft cloth. Do not use solvents such as alcohol or benzene.

■ Descaling

The water in some areas is hard and contains lime, so it is recommended to use a water softening agent periodically, or use a descaler according to the descaler manufacturers' instructions. Do this separately from any laundry washing.



■ After each wash

Leave the door open for a while to dry the drum. This helps to prevent the growth of mold and stagnant smells forming inside the washing machine.

■ Maintenance wash

It is recommended to run the Tub Clean program regularly. Using this program keeps the drum clean and prevents the growth of mold.

Troubleshooting

Problem	Possible Cause	Solution
Door cannot be opened.	<ul style="list-style-type: none"> • There is still some water in the washing machine. • Child lock may be activated. • Washing machine may be switched off before the door lock is released. 	<ul style="list-style-type: none"> • Run the Drain program to drain water. • Deactivate the child lock. (See page 7) • Push the Power button to switch power on. The door lock will be released if there is no water in the drum.
Buttons do not work.	<ul style="list-style-type: none"> • Child lock may be activated. • Settings cannot be changed while a program is in progress. 	<ul style="list-style-type: none"> • Deactivate the child lock. (See page 7)
Water is not supplied.	<ul style="list-style-type: none"> • The water tap may not be turned on. • The water supply hose may be frozen. • The water supply hose may be kinked or pinched. • The water supply filter may be clogged. 	<ul style="list-style-type: none"> • Turn on the water tap. • Make sure that the water supply hose is not frozen. • Straighten the water inlet hose. • Clean the water inlet filter. (See page 20)
Displayed remaining time changes.	<ul style="list-style-type: none"> • Washing time may be prolonged if the load is unbalanced, as the washing machine tries to correct the imbalance. • Washing time may be prolonged when there is too much foam, as the additional action of eliminating it is necessary. • The remaining time is continually corrected and may change during the program. 	<ul style="list-style-type: none"> • This is not a malfunction. • Use the appropriate amount of detergent. • This is not a malfunction.
There's no foam or hardly any foam.	<ul style="list-style-type: none"> • The amount of foam varies depending on the temperature, level of soiling and water hardness. • Detergent may remain undissolved if it is poured directly into the drum. 	<ul style="list-style-type: none"> • Use the appropriate amount of detergent.
There's a lot of foam.	<ul style="list-style-type: none"> • You may have used too much detergent. • The amount of foam varies depending on the temperature, level of soiling and water hardness. 	<ul style="list-style-type: none"> • Use the appropriate amount of detergent.
Detergent in the dispenser  is not washed away.	<ul style="list-style-type: none"> • You may not have selected the Prewash option. • The detergent in the dispenser  is for prewash only. 	<ul style="list-style-type: none"> • If you are using prewash, push the Prewash button.

Troubleshooting

Problem	Possible Cause	Solution
Rinsing begins before spinning finishes.	<ul style="list-style-type: none"> ● If there is imbalance in the drum, rinsing restarts automatically to correct it for safety reasons. 	<ul style="list-style-type: none"> ● This is not a malfunction.
The drum stops and rotates repeatedly during spin.	<ul style="list-style-type: none"> ● If there is imbalance in the drum, the washing machine tries to correct the imbalance by repeatedly rotating and stopping. 	<ul style="list-style-type: none"> ● This is not a malfunction.
Spin cycle repeatedly starts and stops.	<ul style="list-style-type: none"> ● Intermittent spinning of the tub helps the spin process to operate quietly. ● The laundry may be too light. 	<ul style="list-style-type: none"> ● Add one or two bath towels to the drum.
Foam remains on the door or the door seal.	<ul style="list-style-type: none"> ● You may have used too much detergent. ● Laundry is new or not that soiled. 	<ul style="list-style-type: none"> ● Use the appropriate amount of detergent.
Fabric softener overflows.	<ul style="list-style-type: none"> ● You may have exceeded the max. level of softener in the detergent dispenser . 	<ul style="list-style-type: none"> ● Do not pour in more than the max. level of softener.
Fabric softener remains.	<ul style="list-style-type: none"> ● The softener cover may have come out. 	<ul style="list-style-type: none"> ● Firmly set the softener cover on the detergent dispenser.
There's detergent powder residue in the detergent dispenser.	<ul style="list-style-type: none"> ● You may have used too much detergent. ● You may have poured detergent in the detergent dispenser when it was wet. Wipe the water away before adding detergent. 	<ul style="list-style-type: none"> ● Use the appropriate amount of detergent. ● Wipe the water away before adding detergent.
The washing machine switches off during operation.	<ul style="list-style-type: none"> ● There may be noise from other electrical appliances nearby such as a TV, a radio, etc. ● The motor may be locked due to overload, the clothes being trapped in the rubber seal, etc. 	<ul style="list-style-type: none"> ● Unplug the power cord and plug in again. Then select a program and start. Do not place electrical appliances close to the washing machine. ● This is not a malfunction. Wait for about one hour and restart the program.
Odor in the washing machine	<ul style="list-style-type: none"> ● Rubber parts may give off a smell when you first start using the washing machine. ● There may be mold, dirt or detergent residue on the drum. 	<ul style="list-style-type: none"> ● The smell goes away over time. ● Run the Tub Clean program.
Unsatisfactory washing results	<ul style="list-style-type: none"> ● You may have used too little detergent. ● You may have poured detergent directly into the drum. 	<ul style="list-style-type: none"> ● Use the appropriate amount of detergent. ● Pour detergent in the appropriate dispenser.

Troubleshooting

Problem	Possible Cause	Solution
Unusual noise or vibration	<ul style="list-style-type: none"> ● The transport bolts may not have been removed. ● The washing machine may be installed on a sloping or unstable surface. ● There may be foreign objects inside the drum. 	<ul style="list-style-type: none"> ● Remove the transport bolts before using. ● Install the washing machine on a horizontal, stable surface. ● Remove foreign objects such as coins, pins, etc. from the drum.
Noise during drain cycle	<ul style="list-style-type: none"> ● This is normal. There may be noise when the drain pump is on. 	<ul style="list-style-type: none"> ● This is not a malfunction.
There's the sound of water when the drum is rotated manually.	<ul style="list-style-type: none"> ● This is normal. Liquid is inside the 4-Ply Liquid Load Balancer fixed onto the drum to make it balanced. 	<ul style="list-style-type: none"> ● This is not a malfunction.
Tapping noise comes out at spin start.	<ul style="list-style-type: none"> ● This is normal. Tapping sound is generated when laundry touches to the laundry protection bulge on the laundry inlet. 	<ul style="list-style-type: none"> ● This is not a malfunction.
Detergent dispenser is wet.	<ul style="list-style-type: none"> ● In some environmental or usage conditions, Detergent dispenser may get wet due to condensation. 	<ul style="list-style-type: none"> ● This is not a malfunction.
Water remains in washing machine before initial use.	<ul style="list-style-type: none"> ● There may be drops of water or condensation in the washing machine due to the factory inspection prior to shipment. 	<ul style="list-style-type: none"> ● This is not a malfunction.

Error Codes

Code	Description	Possible Cause	Solution
C01	Water is not supplied.	<ul style="list-style-type: none"> • Water tap may not be turned on. • Water inlet filter may be clogged. • Water line or water hose may be frozen. • Water supply may be cut off. 	Check water tap, water inlet filter, water line and water hose.
C02	Water is not drained.	<ul style="list-style-type: none"> • Drain hose or drain pump may be clogged. • Drain hose may be kinked or frozen. • Drain hose may not be set correctly. • Height of the drain outlet may be too high. 	Check drain hose, drain pump and drain outlet. If C02 still appears after removing the possible cause, please contact your local service center for repair.
C04	Spin cycle does not function.	<ul style="list-style-type: none"> • Clothes may be imbalanced in the drum. • You may be washing only one heavy item such as a cotton blanket or jeans, or small items in a laundry net. • You may be washing too many large items such as bed sheets. • The washing machine may be installed on a slanting floor or may not be level. • You may be washing waterproof or antislip treated items. <p>→ Page 10 : Before You Start Washing (Sorting of the laundry)</p>	Add a few clothes to the drum. (Spinning only one item may result in imbalance.)
C08	Door lock does not function.	<ul style="list-style-type: none"> • The door may be open. • The door may not be closed completely. 	Check the door and close firmly.
C09	Door unlock does not function.	<ul style="list-style-type: none"> • Laundry may be exceeded rated load and door is pushed from inside. 	Switch power off and press the door to close tightly. Hold that position and switch power on, and wait until the door lock is released.
C14	Malfunction of vibration sensor	<ul style="list-style-type: none"> • There may be other appliances that generate electrical noise near the washing machine. 	Move the appliances away from the washing machine.
C18	Spin cycle does not function.	<ul style="list-style-type: none"> • The drain hose may not be set correctly. • There may be too much foam in the drum. 	Same as in C02 & C20.
C19	Over loaded	<ul style="list-style-type: none"> • Laundry may exceed rated capacity. 	See page 15 for max. load of each program.
C20	Drum does not rotate.	<ul style="list-style-type: none"> • There may be too many clothes. • Clothes may be tangled. • There may be too much foam in the drum. • The power cord may be extended too far. • There may be other equipment connected to the same power socket. 	To eliminate the excessive foam, switch off the washing machine and wait for about 30 mins, then switch on again and select Rinse & Spin without adding detergent.
C30	Water flows out from drain hose while washing.	<ul style="list-style-type: none"> • Drain hose end is set lower than 60 cm. 	See page 26 for proper height on drain hose setting.

How to Install the Washing Machine

Safety Instructions

- The washing machine is heavy. Use caution when lifting it.
- When lifting the washing machine, do not hold the jog dial or the detergent dispenser casing. Lift the washing machine with two persons holding the bottom and the back of the washing machine.



- Frozen hoses may tear/burst. Do not install the washing machine in areas where there is a risk of freezing, or outdoors.
- If the power supply plug is damaged, in order to avoid hazard, it must only be replaced by an authorized service agent or repair shop appointed by the manufacturer.
- Make sure to earth the unit. Failure to earth the unit may cause electric shock if an electric leak takes place.

Dimensions

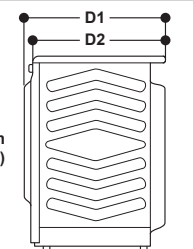
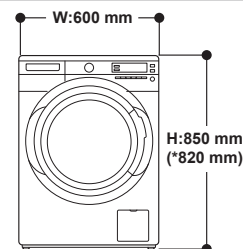

	BD-80XFV	BD-90XFV
D1	584 mm	624 mm
D2	560 mm	600 mm

(BD-80XFV)

*Max. depth when the door is closed: 594 mm

(BD-90XFV)

*Max. depth when the door is closed: 634 mm

(*Height without worktop for under-counter installation)

Where to install the washing machine

- Install the appliance on a flat hard floor to avoid excessive vibration and noise.
- Do not install the unit in humid places such as a bathroom or places that are exposed to wind and rain.
- Keep the minimum installation distance from the walls to prevent abnormal sound and vibration.

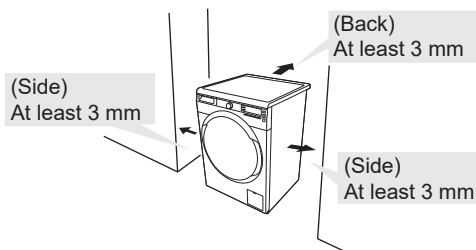

How to Install the Washing Machine

Removing the transport bolts

- Remove the four transport bolts and insert the cover caps using the packed-in 13 mm box spanner.
- The transport bolts must always be removed before using the washing machine for the first time and must be retained for any subsequent transport (e.g. when moving).

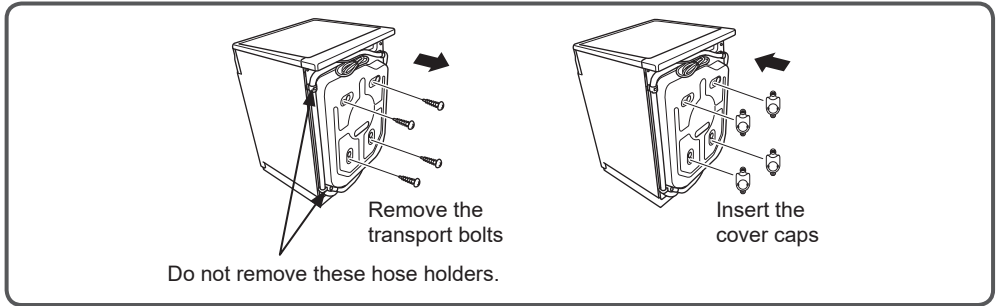

Hose and cable length

• Connection on the left side

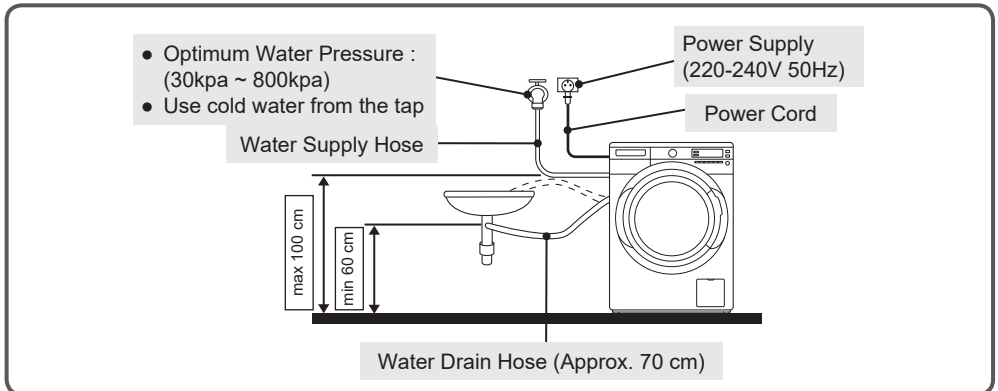

• Connection on the right side

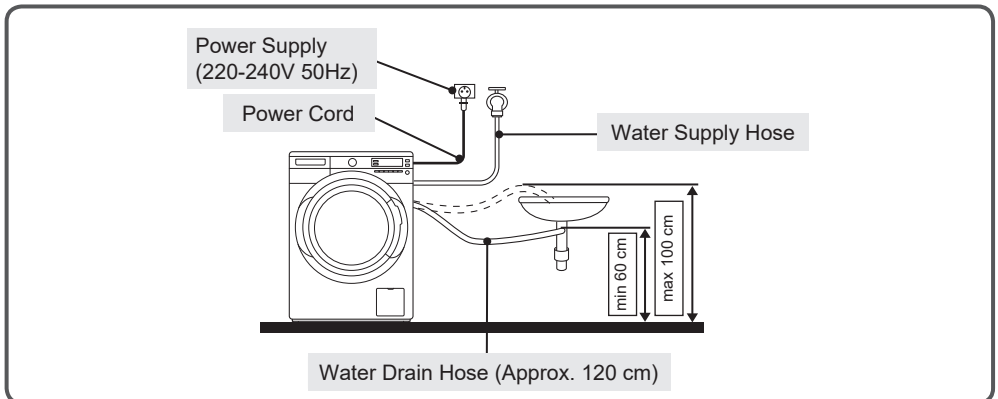

How to Install the Washing Machine

Connecting the water supply

• Water supply hose

- Optimum water pressure is 0.03-0.8MPa.
- Do not connect to the mixer tap of an unpressurised hot-water apparatus.
- Use a horizontal tap.

Horizontal tap



Extension tap



Square tap

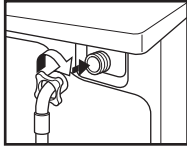

Connect the water supply hose to the rear panel of the washing machine. Make sure that the rubber seal is inside the hose connector.

Hose connector

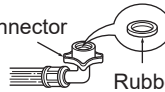

Rubber seal

* Model with SCREW TYPE water supply hose.

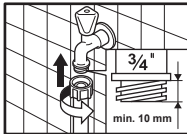

Firmly connect the water supply hose to the tap, and check connection points for water-tightness.

* Model with ONE TOUCH JOINT water supply hose.

1. Untighten the upper connector screw.

Upper connector Rubber packing



- In case the diameter of the tap is large, remove the guide plate.

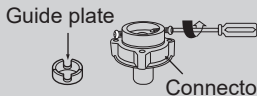

2. Push the upper connector up till the rubber packing is in tight contact with the tap. Then tighten the 4 screws.

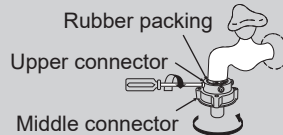

- Turn the middle connector so that there is no water leak.

3. Connect the water supply hose to the middle connector, pushing the plate down.

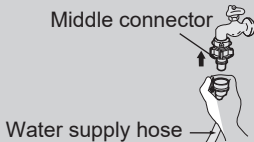

- To separate the water supply hose from the middle connector, turn off the tap, and then pull the inlet hose down, pushing the plate down.

How to Install the Washing Machine

- Make sure that the union nut between the water supply hose and main unit is tightly screwed.
- Turn the tap on to check if the water supply hose is properly connected before starting. If it is loosely connected, water leakage may occur.

● Drain hose

- The drain hose should be placed higher than 60 cm above and not higher than 100 cm above the floor.

If the drain outlet is lower than 60 cm, a joint pipe is necessary (additional part, sold at a specialist outlet). Secure the drain hose to prevent from slipping out from joint pipe.

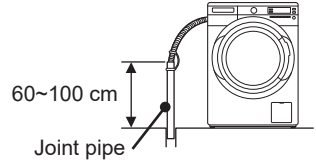

- Do not bend, twist, crush or pull out, bend or step on the drain hose. Use the hose guide to prevent the drain hose from kinking.
- Do not detach the drain hose from the rear panel of the washing machine.

Drainage into a wash basin (Using the packed-in hose guide) :

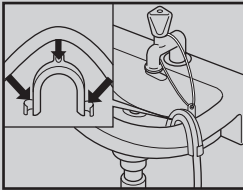

- Secure the drain hose to prevent it from slipping out of the wash basin.
- The wash basin outlet must not be sealed by a plug.
- When water is being pumped out of the washing machine, check that the water drains away quickly enough.

Drainage into a siphon :

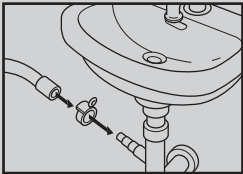

- Secure the connection point with 24-40 mm ϕ hose clip (Sold at a specialist outlet).

How to Install the Washing Machine

Connecting the power

- Connect the washing machine to an alternating current via a correctly installed earthed socket only.
- The mains voltage must correspond to the voltage specification on the washing machine.
- Connection specifications as well as the required fuses are stipulated on the washing machine nameplate.
- Do not plug the washing machine into an extension lead or power strip with multiple sockets.

Level Adjustment

- All four adjustable feet must be firmly on the ground. The washing machine must not wobble.
- Check the alignment of the washing machine with a spirit level, and adjust the feet if it's not aligned.

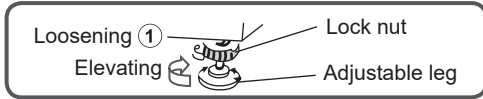

Loosen the lock nut by unscrewing in the arrow direction ① then stabilize the unit with the adjustable feet.



After adjustment, tighten the lock nut by screwing it in the arrow direction ②.

Plastic base plate

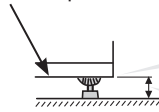

Tighten the lock nut until it reaches the plastic base plate.

Adjustable leg is not over 25 mm.

Under-counter installation

- You need a space at least 3 mm of clearance on the sides, above and back.
- If the height of the space ranges from 823 mm to 852 mm, use upper plate (sold separately).

Upper Plate :
Part No. BD-W80MV 150
Please contact your local dealer when installing the upper plate.

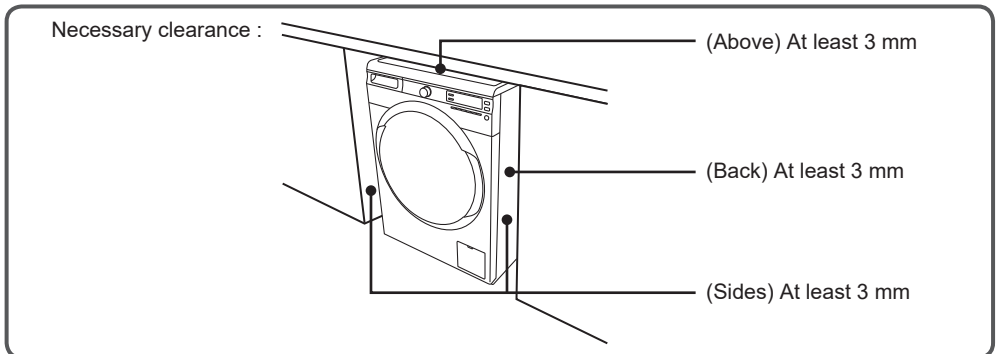
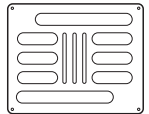

- For neater installation under the counter, check the height of internal measurement before fitting and adjust to the appropriate height with the adjustable feet.
→ How to Install the Washing Machine (Level Adjustment).

How to Install the Washing Machine

Checking after installation

- 1 Turn on the water tap and close the washing machine door.
- 2 Press the Power button to switch power on.
- 3 Select the Cotton program and press the Start/Pause button.
- 4 After 5 minutes, check if there is no water leakage from anywhere.
- 5 Press the Power button to switch power off.
- 6 Press the Power button again to switch power on.
- 7 Select the Spin program and press the Start/Pause button.
- 8 Check if there is no abnormal vibration or sound, and that water is drained out properly.

If any of the following conditions or other abnormalities occur, immediately pull out the power plug to prevent an accident and contact your local service center.

- The washing machine does not operate when you switch power on.
 - The power cord has cracks.
 - There are abnormal vibrations and sounds during operation.
 - There is a smell of burning.
-

Before the first wash

Select the Cotton program with water temperature at 60°C setting and allow the unit to wash without clothing. This will remove residues and water that may have been left in the drum during manufacturing.

Customer Service

In case of malfunction of the washing machine, please check these Operating & Installation instructions carefully before you call for repair services.

If you are unable to identify or solve the problem, please contact your local service center.

Before calling, make a note of the model name, serial no. and purchase date of your washing machine. You can find the model name and serial no. on the label attached to the filter cover.

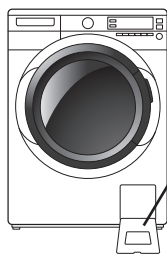

Model Name : XX-XXXXXX
Serial No : XXXXXXXX

Consumption Values

Model	Program	Load	Temperature	Option	Spin speed	Consumption value**		Time (about)
						Power	Water	
BD-90XFV	Cotton	9 kg	40°C	-	1200 r/min	0.74kwh	94L	1:33h
	Cotton Eco	9 kg	40°C	-	1200 r/min	0.76kwh	61L	2:39h
			60°C	Intensive	1600 r/min	0.80kwh	51L	3:37h *
	Rapid 15	2 kg	30°C	-	800 r/min	0.15kwh	25L	0:15h
	Synthetic	4.5 kg	40°C	-	800 r/min	0.61kwh	55L	1:10h
	Mix	4.5 kg	40°C	-	800 r/min	0.60kwh	77L	1:19h
	Delicate	4.5 kg	40°C	-	800 r/min	0.60kwh	66L	1:25h
	Outdoor	4.5 kg	60°C	-	1200 r/min	1.53kwh	88L	2:04h
	Duvet	2.5 kg	30°C	-	800 r/min	0.41kwh	92L	1:30h
	Daily 45	6 kg	40°C	-	800 r/min	0.44kwh	50L	0:45h
	Allergy Care	4 kg	90°C	-	1200 r/min	2.65kwh	140L	2:53h
	Wool	2 kg	30°C	-	400 r/min	0.35kwh	71L	0:53h
	Crease Care	4.5 kg	40°C	-	800 r/min	0.68kwh	76L	1:45h

* Program, temperature, option and spin speed are used to measure the data entered in energy label in compliance with EN60456 IEC60456 standards.

** Consumption values may differ from the indicated values depending on the water pressure, water hardness, water inlet temperature, ambient temperature, type and amount of laundry and degree of soiling, detergent brand, and selected options.

Specifications

Model	BD-90XFV
Power supply	See the rating plate attached to the rear of the washer
Standard water level	24L (Highest water level)
Standard amount of water used	51L (Cotton Eco course)
Water pressure	0.03-0.8 MPa (0.3-8 Kgf/cm ²)
Dimensions	W 600 mm. x D 624 mm. x H 850 mm.
Weight	63 kg.

Consumption Values

Model	Program	Load	Temperature	Option	Spin speed	Consumption value**		Time (about)
						Power	Water	
BD-80XFV	Cotton	8 kg	40°C	-	1200 r/min	0.65kwh	90L	1:33h
	Cotton Eco	8 kg	40°C	-	1200 r/min	0.68kwh	55L	2:39h
			60°C	Intensive	1600 r/min	0.69kwh	44L	3:37h
	Rapid 15	2 kg	30°C	-	800 r/min	0.15kwh	25L	0:15h
	Synthetic	4 kg	40°C	-	800 r/min	0.54kwh	49L	1:10h
	Mix	4 kg	40°C	-	800 r/min	0.53kwh	70L	1:19h
	Delicate	4 kg	40°C	-	800 r/min	0.53kwh	57L	1:25h
	Outdoor	4 kg	60°C	-	1200 r/min	1.20kwh	85L	2:04h
	Duvet	2.5 kg	30°C	-	800 r/min	0.41kwh	85L	1:30h
	Daily 45	6 kg	40°C	-	800 r/min	0.44kwh	50L	0:45h
	Allergy Care	4 kg	90°C	-	1200 r/min	2.50kwh	130L	2:53h
	Wool	2 kg	30°C	-	400 r/min	0.35kwh	63L	0:57h
	Crease Care	4 kg	40°C	-	800 r/min	0.52kwh	70L	1:45h

* Program, temperature, option and spin speed are used to measure the data entered in energy label in compliance with EN60456 IEC60456 standards.

** Consumption values may differ from the indicated values depending on the water pressure, water hardness, water inlet temperature, ambient temperature, type and amount of laundry and degree of soiling, detergent brand, and selected options.

Specifications

Model	BD-80XFV
Power supply	See the rating plate attached to the rear of the washer
Standard water level	21L (Highest water level)
Standard amount of water used	44L (Cotton Eco course)
Water pressure	0.03-0.8 MPa (0.3-8 Kgf/cm ²)
Dimensions	W 600 mm. x D 584 mm. x H 850 mm.
Weight	61 kg.