

Instruction Manual

Hitachi

Cordless Stick Vacuum Cleaner

Model

PV-XH3M

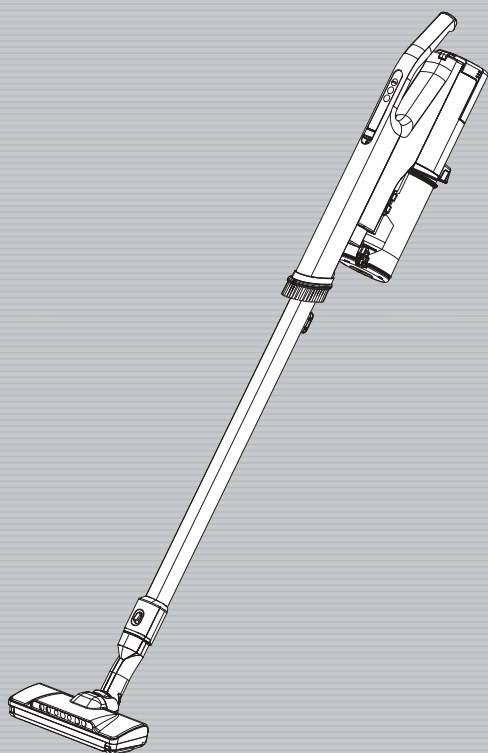

Thank you for purchasing a Hitachi Cordless Stick Vacuum Cleaner.

This vacuum cleaner is intended for use in domestic households only and not designed for commercial use.

To ensure proper use, read this manual carefully before using the vacuum cleaner. For future reference, keep this manual in an easily accessible place.

To ensure proper use, read the safety precautions → (P.EN-2 to EN-6).

HITACHI

Contents

Before using the vacuum cleaner

Safety precautions	EN-2
Usage notes	EN-6
Part names and assembly.....	EN-7
Attachments and assembly	EN-8
Storing the vacuum cleaner	EN-8

Using the vacuum cleaner

Controls and indicators	EN-9
Control buttons.....	EN-9
Indicator during charging.....	EN-9
Indicators during use	EN-10
Assembling the charging station ...	EN-11
Charging the vacuum cleaner	EN-12
Disassembling the charging station ...	EN-13
Using the vacuum cleaner	EN-14
Using the attachments.....	EN-15
Power head.....	EN-15
Handy brush.....	EN-16
Mini power brush.....	EN-17
2-way crevice nozzle	EN-18
Multi angle nozzle with brush.....	EN-19

After vacuuming completes

Emptying the dust case and cleaning the filters	EN-20
Checking the level of dust and debris in dust case....	EN-20
Emptying the dust case.....	EN-20
Cleaning the filters	EN-23
Attaching the dust case	EN-25
Maintenance	EN-26
Vacuum cleaner, attachments, attachment accessories...	EN-26
Washable Parts.....	EN-26
Maintaining (washing with water) the filters.....	EN-27
Cleaning the power heads.....	EN-29
Maintaining the power head	EN-29
Maintaining the mini power brush	EN-31

Appendix

Troubleshooting.	EN-33
Replacing the battery and disposing of the vacuum cleaner	EN-36
Replacing the battery	EN-36
Disposing of the vacuum cleaner....	EN-37
Specifications	EN-38

Safety precautions

Please follow these safety precautions.

This section describes safety precautions that must be followed in order to prevent injury to the user or other people, or damage to property. Please thoroughly read and follow the precautions in this manual.

- The severity of injury or damage that might occur if these precautions are ignored or the vacuum cleaner is used improperly is classified and explained below. Hitachi is not responsible for any injury or damage that occurs as a result of ignoring these precautions.



DANGER

This indicates warnings that, if ignored, could present imminent danger of serious injury or death.



WARNING

This indicates warnings that, if ignored, could result in serious injury or death.



CAUTION

This indicates warnings that, if ignored, could result in minor injury or property damage.

Warning symbols used in this manual



This indicates warnings or cautionary notes.



This indicates prohibited actions that must not be performed.



This indicates instructions that must be followed.

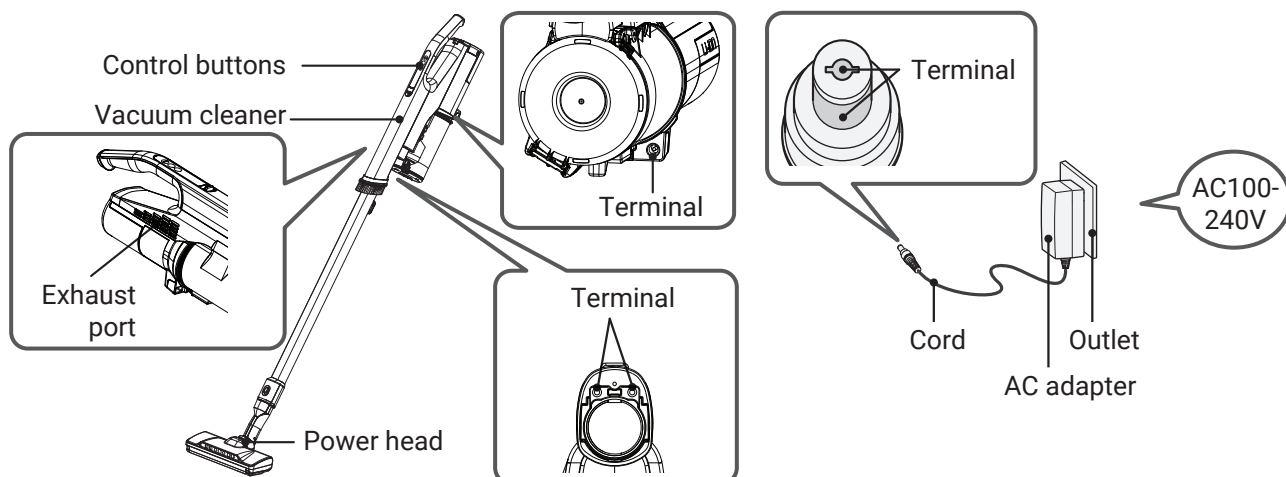

DANGER



- **Do not repair or modify any part of the vacuum cleaner. Do not disassemble any part of the vacuum cleaner unless instructed to in this manual.**
Failure to heed this warning might cause leaking of the battery, the generation of heat, fire, or injury. For repairs, please contact a Hitachi authorized service agent.
- **Keep the vacuum cleaner and AC adapter away from water and other liquids.**
Failure to heed this warning might lead to rupturing of the battery, fire, malfunction, or electric shock.
- **Do not connect the terminals of the vacuum cleaner and AC adapter with metal objects such as a wire and pin.**
Do not carry or store with metal necklaces, hairpins, etc.
Failure to heed this warning might cause the vacuum cleaner to malfunction or cause the battery to short-circuit, resulting in leaking, the generation of heat, rupturing, or fire.
- **Do not throw into fires or apply heat.**
- **Do not charge, use, or leave near sources of heat such as fire or a stove, under direct sunlight or in cars exposed to the sun, etc.**
Failure to heed this warning might cause the battery to leak, generate heat, rupture, smoke, fire, deform, or malfunction.

! WARNING

If the vacuum cleaner malfunctions or you notice any of the following problems, stop using the vacuum cleaner immediately.



- The vacuum cleaner does not turn on when you press a control buttons, even though the battery is fully charged.
- The power turns on and off when you move the AC adapter cord or connector.
- The vacuum cleaner sometimes stops in the middle of operation.
- The vacuum cleaner makes strange sounds in the middle of operation.
- The vacuum cleaner or AC adapter is deformed or abnormally hot.
- The power cord is damaged or abnormally hot.
- It smells like something is burning.
- You notice some other problem or malfunction.

Continuing to use the vacuum cleaner under these conditions could result in smoke, fire, or electric shock. Turn off the vacuum cleaner immediately and unplug the AC adapter from the outlet. Then, contact a Hitachi authorized service agent to request an inspection and repair.

Outlet, plug, cord, and AC adapter



- **Use an AC220-240V outlet.**
Do not use an extension cord, and do not plug the AC adapter in the same outlet as other appliances.
- **Periodically clean the plug of any dust and debris by using a dry cloth.**
- **Insert the plug of the AC adapter all the way into the outlet.**
- **Disconnect the AC adapter from the charging station before performing maintenance on the charging station.**
- **Do not damage the cord.**
(Do not damage or modify the cord. Do not forcefully bend, bundle, pull, or twist it, and do not put it under heavy objects or pinch it between objects.)
- **Do not use the vacuum cleaner if the cord or the AC adapter's plug or connector is damaged, and do not plug the AC adapter into a loose outlet.**
- **Make sure the cord does not get caught in the rotary brush of the power head.**
- **Do not handle the plug (insert the plug into an outlet or remove the plug from an outlet) with wet hands.**
- **Do not touch the terminals on the AC adapter or vacuum cleaner.**
- **To charge the vacuum cleaner, use the AC adapter that was provided with the vacuum cleaner.**
- **Do not attempt to charge the vacuum cleaner by using other AC adapters.**
- **Do not use the AC adapter that was provided with the vacuum cleaner to charge other rechargeable batteries or to charge non-rechargeable batteries.**
Failure to heed this warning might cause fire or electric shock.

Power head, mini power brush



- **Do not touch the rotary brush or the safety switch.**
Failure to heed this warning might cause injury. Be careful especially around children.
- **Do not place the power head or mini power head on parts of your body (on top of your feet, etc.) when pulling the power head or mini power brush.**
Failure to heed this warning might cause injury.

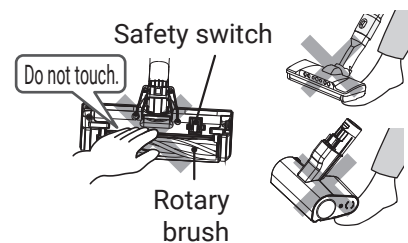

Others



- **Do not use the vacuum cleaner near inflammable or combustible items or materials (kerosene, gasoline, paint thinner, benzene, toner, iron powder, detergents, large amounts of flour, aerosol sprays, flammable gas, cigarette butts, etc.), or to clean up such items or materials.**
- **Do not use the vacuum cleaner to clean up things with sharp points (thumbtacks, needles, toothpicks, hairpins, etc.).**
- **Do not use the vacuum cleaner to clean up suds or foam from carpet cleaners or other types of detergents.**
- **Do not use the vacuum cleaner outdoors.**
- **Do not wash any part of the vacuum cleaner with water unless that part is listed as a part that can be washed. Do not use the vacuum cleaner in the shower or bathtub.**
- **Do not charge or store the vacuum cleaner in a location prone to high humidity.**
Failure to heed this warning might cause eruption, fire, electric shock, or injury.
- **Do not lean the vacuum cleaner against a wall or other surface.**
- **Make sure that the power head is attached when using the vacuum cleaner stand.**
The vacuum cleaner might fall over, becoming damaged or causing injury or damage to the floor.

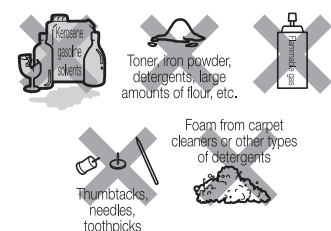

CAUTION

Outlet, AC adapter, cord



- **Hold onto the AC adapter when you unplug it. Do not pull on the cord.**
Pulling on the cord might damage the cord and cause short-circuiting, resulting in electric shock or fire.
- **Do not wrap the cord around the charging station.**
Damaging the cord might cause electrical shock or fire.
- **If you will not be using the vacuum cleaner for a long time, unplug the AC adapter.**
Failure to heed this warning might lead to deterioration of the insulation, causing electric shock, short-circuiting, or fire.

Hold onto the AC adapter.

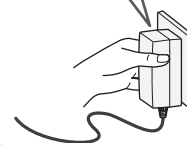

Power head, mini power brush, extension pipe



- **Do not let the vacuum cleaner run for an extended period of time with the inlet blocked.**
Failure to heed this warning might cause overheating, leading to fire or the deformation of the vacuum cleaner and power head or mini power brush.
- **Before performing maintenance on the vacuum cleaner, remove the power head from the vacuum cleaner.**
Failure to heed this warning might cause injury.
- **Do not attach any of the parts of this vacuum cleaner to objects other than this vacuum cleaner.**
Failure to heed this warning might cause overheating, leading to fire or the deformation of the power head or mini power brush.
- **Do not clean using the tip of extension pipe, and do not insert pins or other objects in the connections of this vacuum cleaner, extension pipe.**
Doing so might cause a short circuit resulting in electric shock, fire, malfunction and damage to floors.
- **Do not move the power head or mini power brush left and right while they are facing forward.**
Doing so might damage floors or fabrics.
- **Do not use any of these attachments if any foreign objects (including sand or small pebbles) are stuck to the attachment.**
Failure to heed this warning might result in damage to floors or cloth surfaces.
- **Do not use the vacuum cleaner under or in between blankets.**
Failure to heed this warning might cause overheating, leading to fire or the deformation.

Do not move it left and right

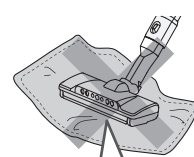

Do not block

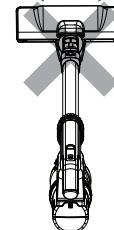

Do not stick pins

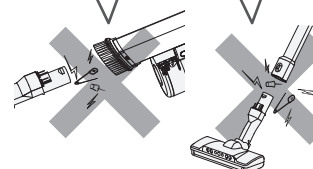

Exhaust port



- **Do not block the exhaust port.**
Failure to heed this warning might cause overheating, leading to fire or the deformation of the vacuum cleaner.
- **Do not expose your body to the air released from the exhaust port for long periods of time.**
Failure to heed this warning might cause minor burns.

Do not expose your body for long periods of time.

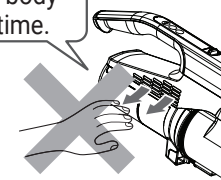

Others



- **When carrying the vacuum cleaner, do not hold the dust case.**
The vacuum cleaner might fall and cause injury or damage the floor.
- **Keep away from fire.**
Failure to heed this warning might cause short-circuiting due to vacuum cleaner deformation, resulting in fire.
If the vacuum cleaner is used near a flame, exhaust from the vacuum cleaner might cause the flame to grow into a conflagration.
- **Turn off the vacuum cleaner before performing maintenance.**
Failure to heed this warning might cause injury.
- **Do not carry the vacuum cleaner while it is set on the charging station.**
The vacuum cleaner might fall off, which could cause an injury or damage the floor.
- **Do not clean using the tip of the vacuum cleaner without the handy brush.**
Failure to heed this warning might cause short-circuiting, resulting in electric shock, fire, or damage to the vacuum cleaner or to the floor.
- **Do not put the charging station where dew condensation occurs or in a humid place.**
This might discolor the wall.
- **Do not drop the vacuum cleaner, power head, extension pipe, AC adapter, charging station, or any of the attachment accessories from high places.**
Failure to heed this warning might cause injury or damage to the floor or dropped part.
- **Do not look directly into the LED lights.**
Doing so might hurt your eyes.
- **Children should be supervised to ensure that they do not play with the appliance.**
- **This appliance is not intended for use by persons (including children) with reduced physical, sensory or mental capabilities, or lack of experience and knowledge, unless they have been given supervision or instruction concerning use of the appliance by a person responsible for their safety.**
- **Only allow children at least 8 years old to use the AC adapter. Give sufficient instruction so that the child is able to use the AC adapter in a safe way and explain that it is not a toy and must not be played with.**
- **Instruct the child not to try and recharge non-rechargeable batteries because of the danger of eruption.**
- **Examine the AC adapter regularly for damage, especially the Cord, plug and enclosure. If the AC adapter is damaged, it must not be used.**
- **Cleaning and user maintenance shall not be made by children without supervision.**



Battery (lithium-ion battery)



DANGER



- **Do not connect the battery to anything other than this vacuum cleaner. Do not disassemble, modify, or solder the battery. Do not charge the battery when it is not connected to the vacuum cleaner. Replacement of the battery is to be performed by a trained service technician. Do not remove the battery except when disposing of this vacuum cleaner.**
Please consult with a Hitachi authorized service agent.
- **Do not touch the terminals or connect them by using metal items such as wires and pins.**
- **Do not transport or store the battery in the same container as metal objects such as necklaces, hairpins, coins, or keys.**
- **Do not subject the battery to strong physical shock. For example, do not put nails into the battery, hit the battery with a hammer, step on the battery, or throw the battery.**
- **Keep away from fire.**
- **Do not leave the battery near sources of heat such as a fire or stove, under direct sunlight, or in a car in the sun.**
- **Do not use any battery other than the one specified for this vacuum cleaner.**
- **Do not put the battery in a microwave or an oven.**
- **Do not submerge the battery in water or other types of liquid, or expose it to water or other types of liquid.**
Failure to heed this warning might cause the battery to leak, generate heat, rupture, smoke, fire, electric shock, or injury.



- **If the liquid inside the battery enters your eyes, do not rub your eyes, but thoroughly wash them with clean water immediately, and then consult a doctor.**
Failure to do so might cause damage to your eyes.



WARNING



- **Do not use the battery if it is leaking or has an abnormal odor, discoloration, deformation, or damage due to being dropped or you notice something unusual.**
Failure to heed this warning might cause the generation of heat or smoke, rupturing, or fire. If liquid from the battery leaks onto the floor, it might damage the floor.
- **Keep the battery away from infants and children.**
Failure to heed this warning might cause electric shock or injury.
- **If the battery is leaking, do not touch it with bare hands.**
Failure to heed this warning might cause skin irritation.
- **Do not touch the battery with wet hands.**
Doing so might cause heat to be generated, a fire, or an electric shock.
- **Do not charge the vacuum cleaner if the battery is not attached.**
Doing so might cause heat to be generated, a fire, or an electric shock.



- **If liquid from the battery gets on your clothes, immediately wash them in clean water. If the liquid gets on your skin, consult a doctor.**
Failure to heed this warning might cause skin irritation.



CAUTION



- **When charging the battery, make sure the ambient temperature is between 5 ° C and 35 ° C.**
Charging the battery in temperatures outside of this range might prevent the battery from being fully charged. As a result, the battery might take a long time to charge, or you might only be able to use the vacuum cleaner for a short time. Failure to heed this warning might cause the battery to deteriorate.
- **If the battery is still charging longer than the specified charging time, unplug the AC adapter.**
- **Do not touch the battery for a long period of time while charging or operating the vacuum cleaner.**
Failure to heed this warning might cause minor burns.
- **Store the vacuum cleaner in a location with low humidity or little dust and debris.**
Failure to heed this warning might cause the generation of heat or smoke, rupturing, or fire.

Usage notes





To prevent malfunction and other problems, be sure to follow these instructions.

Be sure to thoroughly read these instructions, as well as those indicated by **Note** in other locations in this manual, and to use the vacuum cleaner in accordance with these instructions.

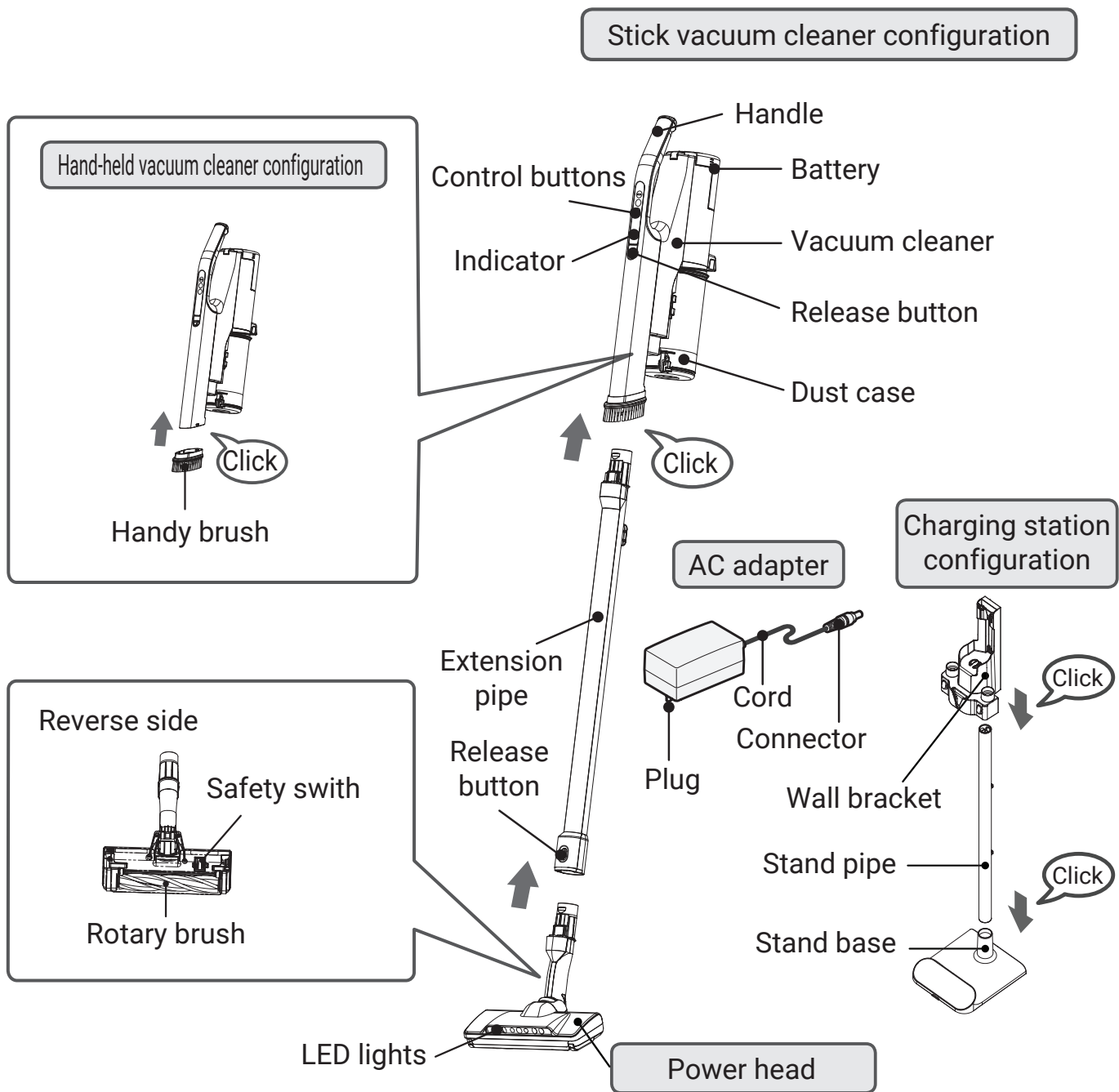
- **Do not subject the vacuum cleaner, the power head, extension pipe, charging station, AC adapter, or attachment accessories to strong physical shock.**
Failure to heed this warning might cause the deformation or damage.
- **Do not use the vacuum cleaner to clean up the following objects.**
Failure to heed this warning might cause strange odors or malfunction.
 - Water or other liquids, wet objects, or desiccants.
 - Large amounts of sand or powder, long string or thread, or glass.
- **Do not ride on the vacuum cleaner, the power head, charging station, or attachment accessories.**
Doing so might cause malfunctions.
- **Thoroughly air dry parts washed with water.**
Failure to heed this warning might cause strange odors or malfunction.
- **Do not remove the battery while the vacuum cleaner is running or being charged.**
Doing so might cause malfunctions.

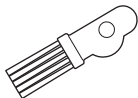
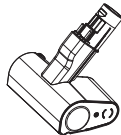
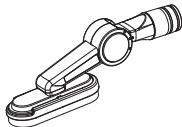
Part names and assembly

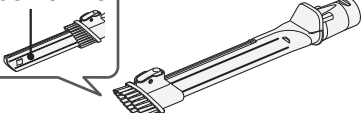

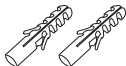
Attachment accessories			
Maintenance brush (1 pc.)  (Attached to the back side of the dust case)	Mini power brush (1 pc.) 	Multi angle nozzle with brush (1 pc.) 	
Handy brush (1 pc.) 	2-way crevice nozzle (1 pc.) Crevice nozzle 	Screws (2 pcs.) 	Screw anchors (2 pcs.) 

Attachments and assembly

Attachments can be attached to the vacuum cleaner and extension pipe.

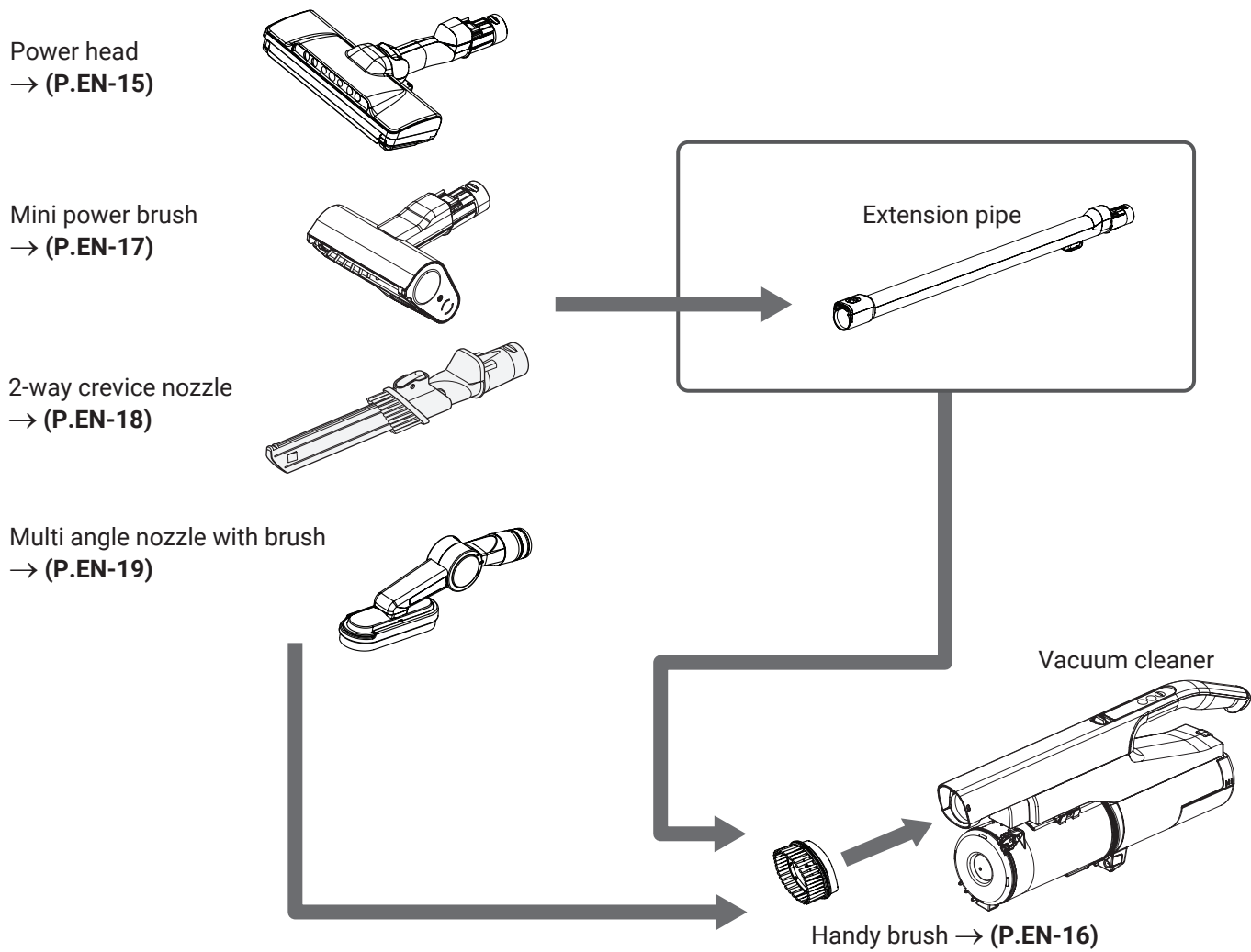

Storing the vacuum cleaner

Storing the vacuum cleaner, extension pipe, and accessories with charging station

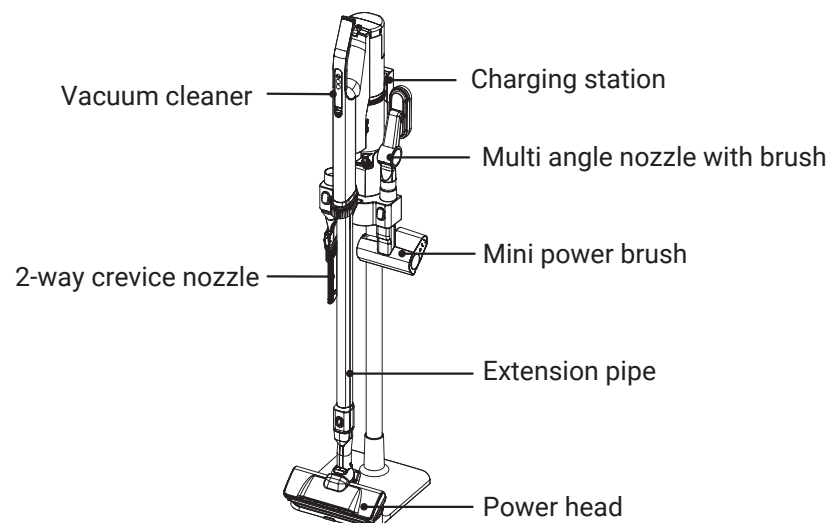

Controls and indicators

Control buttons

To operate

Press the  button.

Each time the button is pressed, the operation status will be the order of "standard" → "high" → "turbo" → "standard"... is switched.

Press 1st for normal cleaning
Press 2nd for careful carpet cleaning
Press 3rd for powerful cleaning in heavily dirty areas.



To automatic operation

Press the  button.

The sensor will sense the type or state of the floor, as well as the operation mode of the electric suction head, and automatically switch between "standard" and "High" operation.

To Stop operation

Press the  button.

Indicator during charging

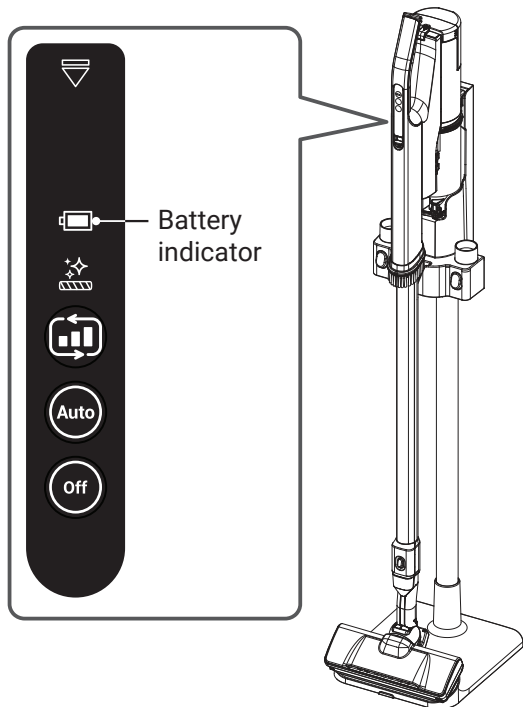

Battery Indicator	Charging status
On	The battery is charging. Charge time is approx. 2.5 hours. Depending On the ambient temperature, usage time, etc, if the battery's temperature is very hot, charging may automatically go into standby until the temperature lowers to an appropriate temperature for charging, causing the charging time to increase. → (P.EN-36)
Off	The battery is fully charged. When the battery is fully charged, the battery indicator turns off.

- * If the battery indicator blinks rapidly (about four times per second), this indicates an abnormality with the AC adapter or the battery. → (P.EN-36)
- * If you remove the vacuum cleaner from the charging station (or disconnect the AC adapter) after the battery indicator turns off, and then set the vacuum cleaner back onto the charging station, the battery indicator turns on, but this does not indicate a problem with the vacuum cleaner.
- * If you remove the battery while charging, after a short time, the indicator blinks (about four times per second). If this happens, remove the vacuum cleaner from the charging station (or disconnect the AC adapter) and then attach the battery back onto the vacuum cleaner. Then, set the vacuum cleaner back onto the charging station or reconnect the AC adapter.

 **WARNING**

- **Do not touch the terminals on the AC adapter or vacuum cleaner.**
Failure to heed this warning might cause electric shock or injury.
- **Do not charge the vacuum cleaner if the battery is not attached.**
Failure to heed this warning might cause malfunction or electric shock.

Note Do not remove the battery while the vacuum cleaner is being charged.

Indicators during use

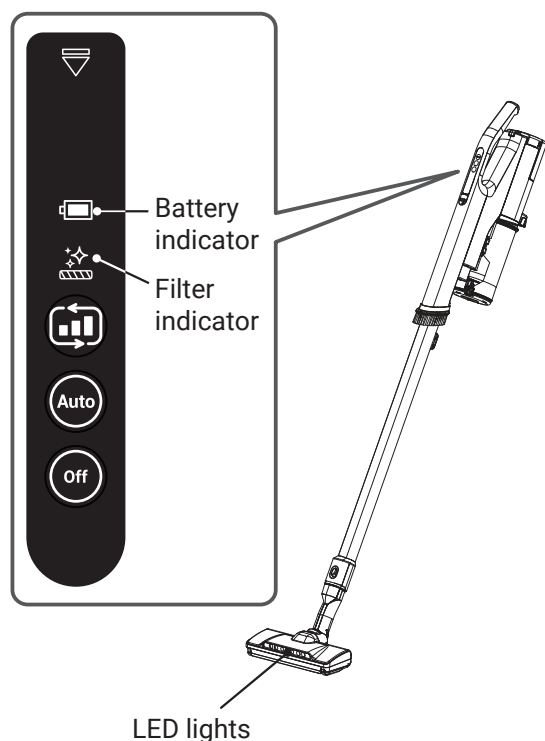

Indicator		Operating status
	Off	The remaining battery level is high.
	Blinking (about two times per second)	The remaining battery level is low. Charge the battery.
	Blinking (about two times per second)	The filter needs to be cleaned. → (P.EN-23, EN-24)

- * If the battery indicator blinks rapidly (about four times per second), this indicates an abnormality with the battery. → (P.EN-36)
- * If the battery indicator blinks slowly (about once per two seconds), this indicates that the vacuum cleaner might be running in safe mode with reduced suction power in order to prevent overheating of the vacuum cleaner's motor or battery. → (P.EN-36)
- * The filter indicator does not blink while the vacuum cleaner is being operated in the Standard setting.
- * If the filter indicator blinks, this indicates that the power head and mini power brush might have automatically turned off (and its LED indicator turned off) in order to prevent overheating of the power head and mini power brush. → (P.EN-33)

If the filter indicator on the vacuum cleaner blinks while the vacuum cleaner is running or after the vacuum cleaner stops:

- Empty the dust case and remove any dust and debris attached to each of the filters. → (P.EN-20 to EN-25)
- If the filter indicator on the vacuum cleaner blinks while the vacuum cleaner is running, even though dust and debris has already been removed from each filter, wash each filter with water. → (P.EN-27 to EN-28)
- Objects might get caught in the rotary brush of the power head. If this happens, remove the object. → (P.EN-29 to EN-30)

Assembling the charging station

Charging station → (P.EN-12)

You can charge the vacuum cleaner by connecting it to the AC adapter directly, instead of using the charging station → (P.EN-12)

1 Insert the connector terminal all the way through the round hole.

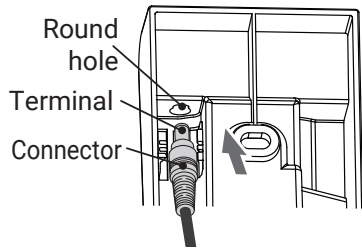

2 Push the connector in the direction indicated by the arrow until the terminal is completely vertical.

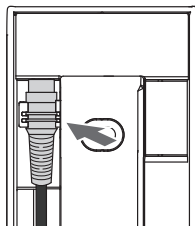

On the charging station, insert the cord between protrusion and protrusion so align the cord in every position.

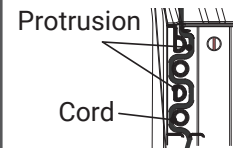

3 Install the charging station to the stand platform by install stand pipe to the stand base, then install the charging station to the stand pipe. Or install the charging station to the wall with two screws and two screw anchors, using appropriate for the wall type. Please ensure that the charging station is mounted securely.

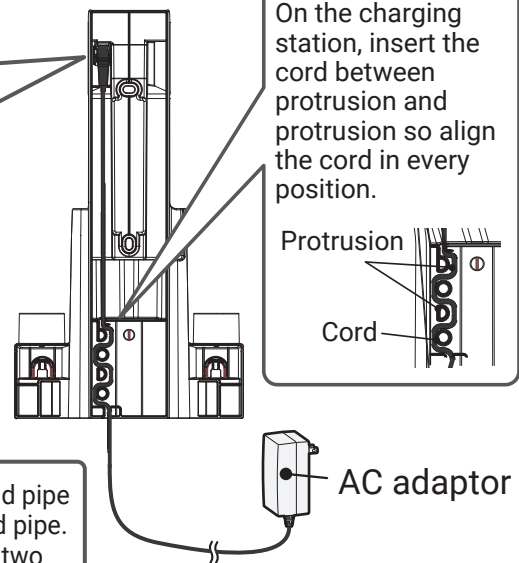

On the charging station

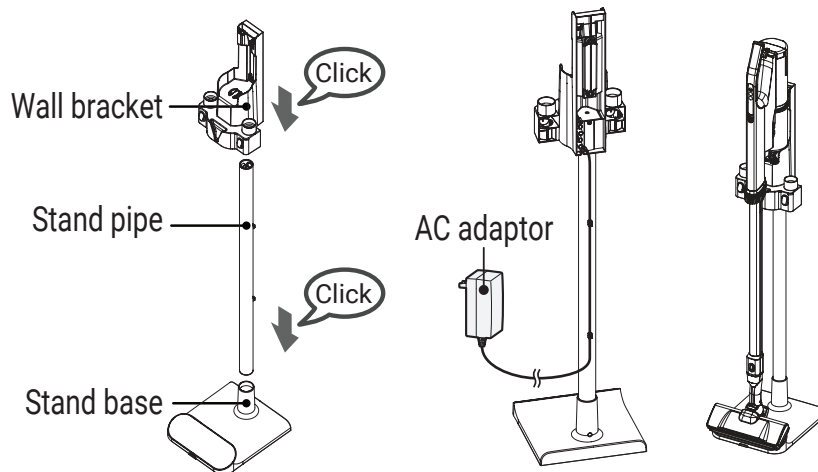

On the wall

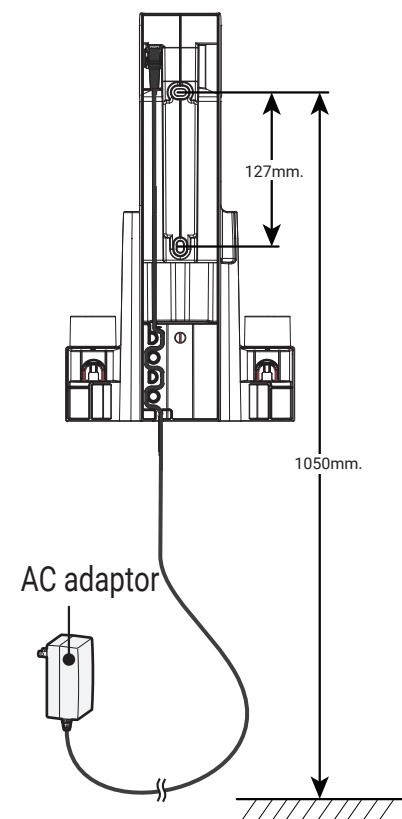

CAUTION

Do not set the vacuum cleaner on the charging station if the vacuum cleaner is being used as a hand-held vacuum cleaner.
The vacuum cleaner might fall off of the charging station, causing injury or damage to the floor.

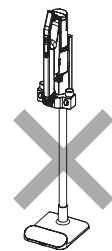

Charging the vacuum cleaner

Charge the battery before using the vacuum cleaner. The battery is not fully charged at the time of purchase. It generally takes about 2.5 hours to charge the battery. (It might take longer to charge the battery depending on factors such as the ambient temperature and how long the vacuum cleaner was in use.)

To charge the vacuum cleaner using the charging station

1

Attach the AC adapter to the charging station.
→ (P.EN-11) Then, plug the AC adapter into an outlet.

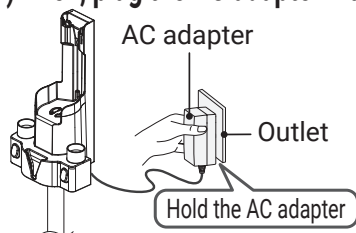

To charge the vacuum cleaner by connecting it to the AC adapter.

Plug the AC adapter into an outlet.

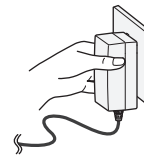

CAUTION

When unplugging the AC adapter, hold the AC adapter. Do not pull on the Cord.
Pulling on the cord might damage the cord and cause short-circuiting, resulting in electric shock or fire.

2

Set the vacuum cleaner on the charging station.

Note If you want to charge the vacuum cleaner by using the charging station, make sure the dust case is attached to the vacuum cleaner.

- Insert the charging station protrusion into the attachment groove of the vacuum cleaner.
- When the vacuum cleaner is set on the charging station and the AC adapter is connected, the battery indicator turns on.
- When fully charged, the battery indicator turns off.

Set the vacuum cleaner on the charging station while the vacuum cleaner is propped up, and insert the charging station protrusion into the attachment groove of the vacuum cleaner.

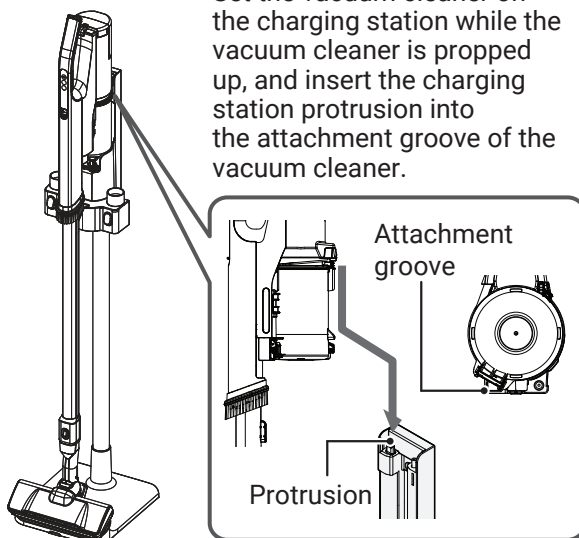

Insert the connector of the AC adapter into the terminal on the vacuum cleaner.



CAUTION

Risk of damage to the floor.

- If you want to charge the vacuum cleaner by connecting the AC adapter to the vacuum cleaner, make sure the vacuum cleaner is resting on the floor or some other flat, level surface.
- Do not drag the vacuum cleaner while it is resting on the floor or any other flat, level surface.

- When the AC adapter is connected to the vacuum cleaner, the vacuum cleaner indicator turns on.
- When fully charged, the battery indicator turns off.

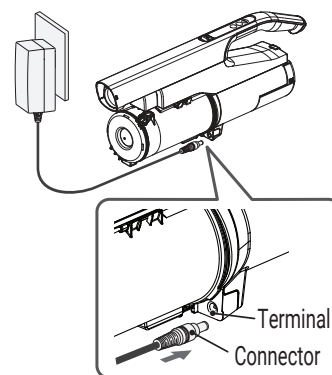

- If you will not be using the vacuum cleaner for a long time, unplug the AC adapter and remove the battery from the vacuum cleaner.
- While the AC adapter is connected to the vacuum cleaner, the battery will be automatically and periodically charged when the remaining battery level becomes low. However, if the vacuum cleaner is left unused for two months or longer, the remaining battery level might become low, even if the vacuum cleaner is connected to the AC adapter and the AC adapter is plugged in. If this happens, before using the vacuum cleaner, remove the connector of the AC adapter from the vacuum cleaner and then insert the connector back into the vacuum cleaner.
- If you disconnect the AC adapter from the vacuum cleaner after the battery indicator turns off (indicating that the battery is fully charged), and then reconnect the AC adapter to the vacuum cleaner, the battery indicator turns on (indicating that the battery is being charged), but this does not indicate a problem with the vacuum cleaner.
- While the vacuum cleaner is being charged, the vacuum cleaner or AC adapter might become hot, but this does not indicate a problem with the vacuum cleaner.
- The vacuum cleaner will not operate even if the control buttons is pressed while charging.

Note

- When charging the battery, make sure the ambient temperature is between 5 ° C and 35 ° C. Charging the battery in temperatures outside of this range might prevent the battery from being fully charged. As a result, the battery might take a long time to charge, or you might only be able to use the vacuum cleaner for a short time.
- If the battery indicator does not turn on, or it turns on briefly and then turns off, remove the vacuum cleaner from the charging station and then set it back onto the charging station.
- If you are using the vacuum cleaner for the first time or after the vacuum cleaner was left unused for a long time, the battery might take a long time to charge, or you might only be able to use the vacuum cleaner for a short time.
- Charging it near a radio might cause sound interference when the radio is in operation. When charging the vacuum cleaner, plug the AC adapter into an outlet that is at least 2 meters away from any radio equipment.

To prolong battery life

- Be sure to charge the vacuum cleaner after each use, even if you only used the vacuum cleaner for a short period of time.
- If the vacuum cleaner is not to be used for more than a month, please fully charge the battery before storing it. Charging it once a year if the vacuum cleaner is not in use will prolong the battery life. (Storing a depleted battery will deteriorate the battery performance and battery life.)
- If the vacuum cleaner stops in the middle of operation because the battery has run out, you might still be able to use the vacuum cleaner for a short while by pressing the control buttons. However, this type of action is not recommended.
Performing this type of action will shorten the battery life.

Disassembling the charging station

1 Unplug the AC adapter.

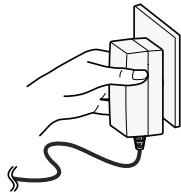

2 Disconnect the cord and connector, and then detach the wall bracket and stand pipe.

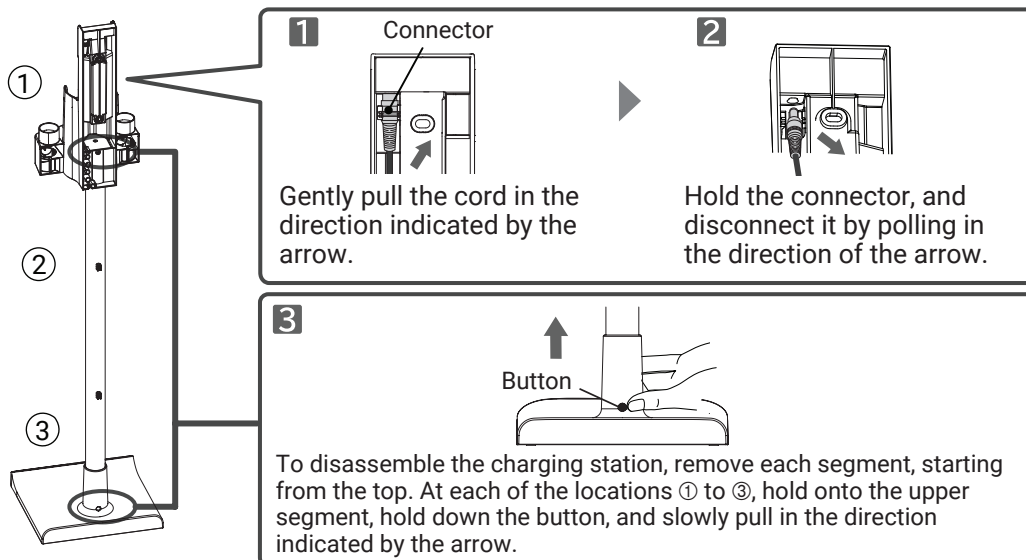

Using the vacuum cleaner

If the vacuum cleaner is set on the charging station.

If the AC adapter is directly connected to the vacuum cleaner.

1 Remove the vacuum cleaner from the charging station.

Hold the handle and pull the vacuum cleaner upward.

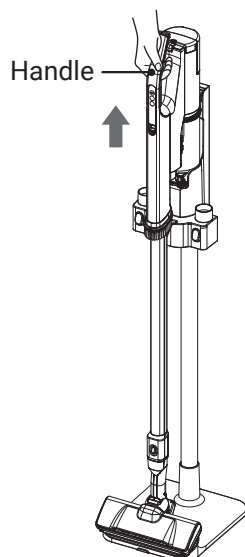

Remove the connector of the AC adapter from the vacuum cleaner.

Holding onto the connector of the AC adapter, disconnect it from the vacuum cleaner.

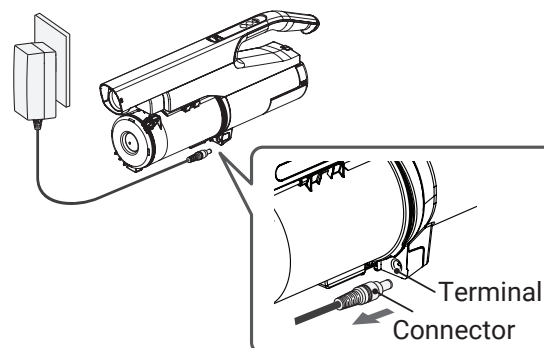

⚠ CAUTION

When disconnecting the AC adapter, hold the connector. Do not pull on the cord.

Pulling on the cord might damage the cord and cause short-circuiting, resulting in electric shock or fire.

2 Attach an attachment. → (P.EN-8)

When replacing an attachment, remove it by sliding the release button and pulling the attachment in the direction of the arrow.

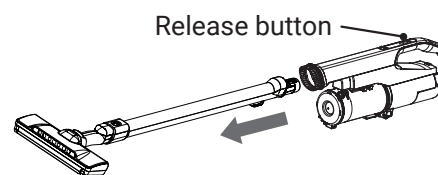

3 Press the or button.

Continuous operating time

Standard [Press 1st]: Approx. 40 minutes (with the power head), 60 minutes (without the power head) →

High [Press 2nd]: Approx. 15 minutes → Turbo [Press 3rd]: Approx. 6 minutes → Auto : Approx. 15 minutes to 40 minutes. Note that these times might be shorter in low temperatures.

⚠ CAUTION

Risk of injury or damage to the floor.

Do not strongly press or hit the vacuum cleaner against the floor. The vacuum cleaner might be deformed or the dust case might fall.

Note Do not remove the battery from the vacuum cleaner while operating. Doing so might cause malfunctions.

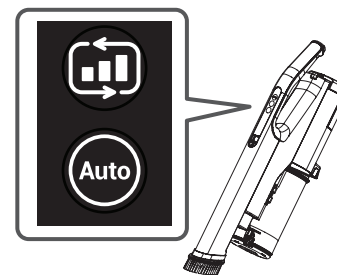

4 To stop, press .

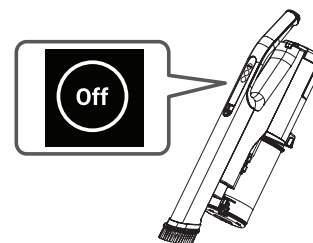

5 Charge the vacuum cleaner after using it. → (P.EN-12)

Using the attachments

Power head

■ Use in accordance with the floor type

Vacuum efficiently and thoroughly by moving the power head back and forth across floor.

Carpet

Clean by moving back and forth. Dust and debris will be collected thoroughly when pulling back.
When cleaning a new carpet for the first time, the cleaner might collect many loose threads.

Flooring/ Tatami

To prevent damage to the floor, move along the grain of the flooring.

- When cleaning a new tatami, its surface might become polished.
- If dust and debris still remain on the floor after you move the vacuum cleaner toward you, lift the power head and then move the vacuum cleaner away from you (back over the dust and debris).



WARNING

Risk of injury

Do not place the power head on parts of your body (on top of your feet, etc.) when pulling the power head.

It might get your body parts caught in the rotary brush.

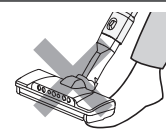

CAUTION

Risk of damage to the floor

When pulling the power head.

Do not firmly press the power head against the floor.

- The floor might be damaged if it is easily damaged especially such as cypress or padded flooring*.
*Padded flooring is flooring where the surface is cushioned using vinyl chloride, etc.
- Firmly pressing the power head against uneven surfaces such as thresholds might wear out the wheels and damage the floor.
- If dust and debris gets tangled in the wheels, the wheels cannot rotate, which might cause wear and tear and floor damage.
Perform periodic maintenance (about once a month).
→ (P.EN-29, EN-30)
- After extended use, the brushes, wheels, and rotary brush might wear down. Using the power head while they are worn out might damage the floor. You cannot replace the brushes or wheels by yourself. Please contact a Hitachi authorized service agent to have the brushes, wheels, and rotary brush replaced as a set.

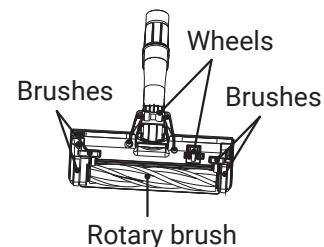
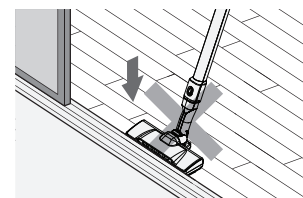

Note

- The vacuum cleaner might be difficult to use depending on the floor type. In such a case, switch to the "Standard" operation.
- If the suction power becomes weak, there might be dust and debris blocking the power head inlet. In this case, perform maintenance for (wash with water) each filter. → (P.EN-27 to EN-28)
- Do not push the power head against the floor with excessive force, because the power head might leave a mark on the floor.
If the power head leaves a mark on the floor, please refrain from using the vacuum cleaner in that area, and remove the mark by using a soft cloth.

■ The safety switch of the power head

When you lift the power head from the floor, the safety switch activates and the rotary brush stops rotating for your safety.

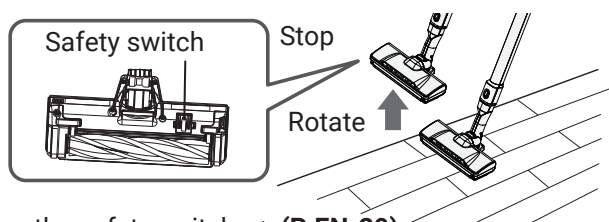

For information on maintaining the safety switch → (P.EN-29)



WARNING

Risk of injury

Do not touch the rotary brush or the safety switch of the power head.

The rotary brush might rotate. Be careful especially around children.

Multi angle head

Turning the handle changes the orientation of the power head. Narrow places can be efficiently vacuumed.

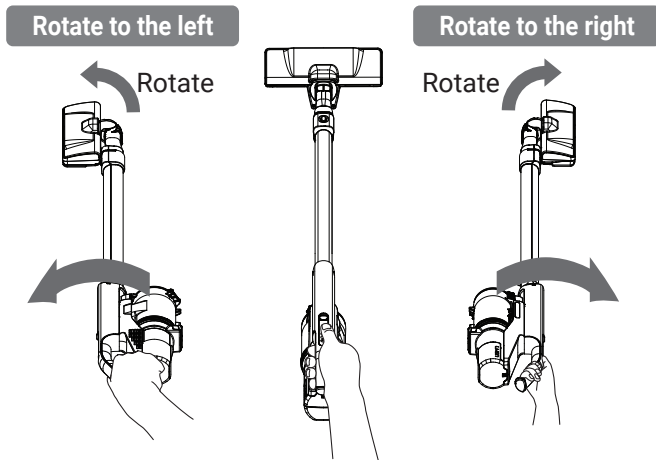

CAUTION

Risk of damage to the floor

- After extended use, the brushes, wheels, and rotary brush might wear down. Using the power head while they are worn out might damage the floor. You cannot replace the brushes or wheels by yourself. Please contact a Hitachi authorized service agent to have the brushes, wheels, and rotary brush replaced as a set.
- Do not move the power head left and right while they are facing forward.
- Do not pull the power head backwards while holding it aloft.

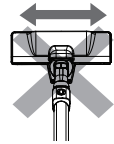

Handy brush

Attach to the vacuum cleaner before use.

Attachments can be applied while the handy brush is attached to the vacuum cleaner.

Attaching the handy brush

- 1 Match the position of the protrusion on the side of the handy brush with the groove on the vacuum cleaner.

Detaching the handy brush

Press the grooved area of the handy brush and pull in the direction of the arrow.

- 2 Press in the direction of the arrow.

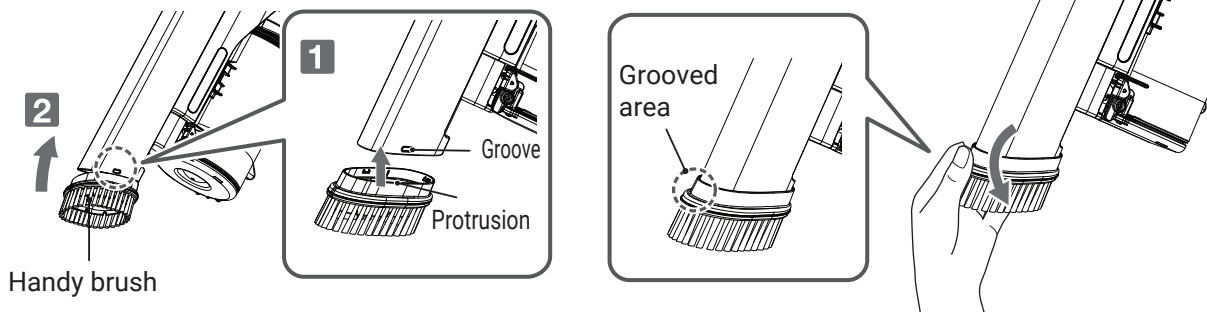

CAUTION

Risk of electric shock, fire, malfunction or damage.

- Do not clean using the tip of the vacuum cleaner without the handy brush.
- Do not press against areas that are particularly easy to be damaged, such as pianos.

Note

- It might be damaged if excessive force is applied. If the handy brush is pressed down on floors with too much force, it might become damaged, crack, or damage to the floor.
- The handy brush can be washed with water. After washing with water, allow it to dry naturally before use. Using it while wet might lead the vacuum cleaner to malfunction.

Mini power brush

This is a compact suction head that can be used on sofas, car seats, and bedding.

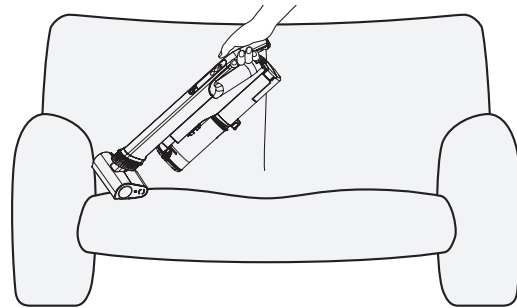
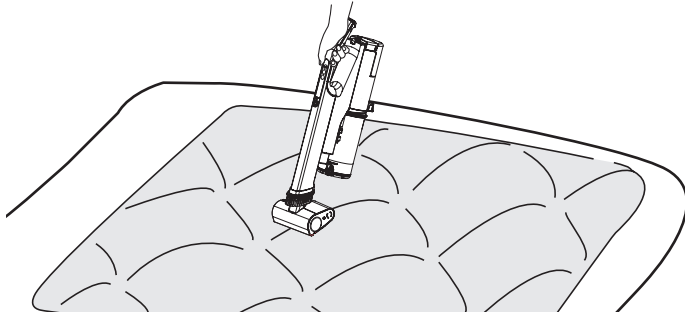

WARNING

Risk of injury

- Do not place the mini power brush on parts of your body (on top of your feet, etc.) when pulling the mini power brush. It might get your body parts caught in the rotary brush.
- Do not touch the rotating rotary brush of the mini power brush. The rotary brush might rotate. Be careful especially around children.

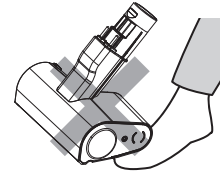

CAUTION

Risk of damage to the fabric.

- Use on bedding, mattresses, bed covers, pillows, seat cushions, fabric sofas, and other fabric products.
- Do not use on wood furniture, wood floors, or locations with a glossy surface that is easily damaged.
- Do not press against fabrics that are easily damaged, such as leather.
- Do not leave the mini power brush stopped in the same position while operating.
- After extended use, the wheels and rotary brush might wear down. Using the mini power brush while they are worn out might damage the fabric.

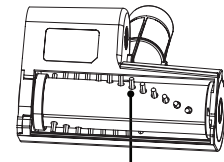

Rotary brush

Note

- When cleaning fabrics, lay the fabric flat, and do not press firmly. If you clean fabrics while folded, they might become tangled and be damaged.
- The vacuum cleaner might be difficult to use depending on the cleaning location. In such a case, switch to the "Standard" operation.
- If the suction power becomes weak, there might be dust and debris blocking the mini power brush inlet. Perform maintenance (clean with water) for each filter. → (P.EN-27, EN-29)
- Do not clean the mini power brush with water. (Only the rotary brush can be cleaned with water.)
- Do not leave the mini power brush in locations with high temperature such as in a car parked under the blazing sun.

2-way crevice nozzle

Swiftly perform cleaning with the brush on the tip.

The mode can be switched to crevice nozzle mode with one touch so it is useful when cleaning book shelves and crevices.

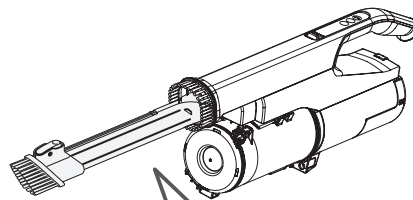
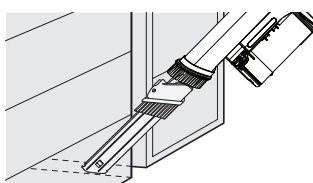
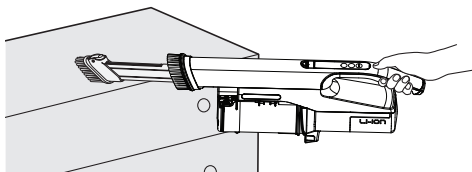

To switch between the crevice nozzle and the crevice brush, hold down the button and slide the brush in the direction indicated by the arrow.

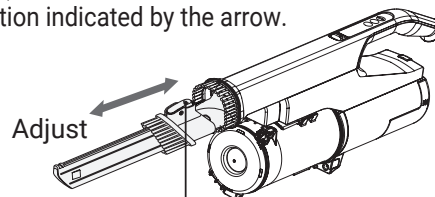

Slide the brush while holding down the button



WARNING

Risk of injury

When sliding the brush, do not hold onto the slide grooves. Your hand might get pinched.

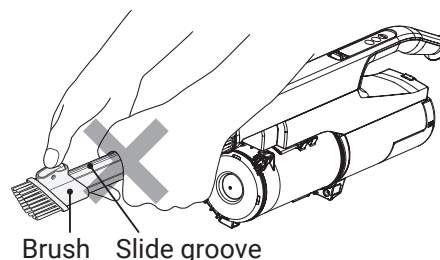

CAUTION

Risk of damage

Do not press against areas that are particularly easy to be damaged, such as pianos.

Note

- It might be damaged if excessive force is applied. Do not drop from high places.
- You can wash the 2-way crevice nozzle. After washing, allow it to dry naturally before use. Using it while wet might lead the vacuum cleaner to malfunction.
- If there is dust and debris on the tip or inside the nozzle, or within the groove of the slide, remove the dust and debris.

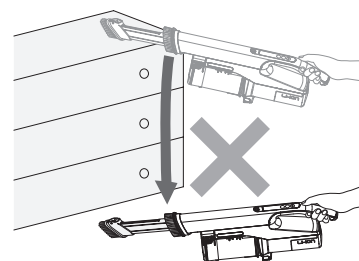

Multi angle nozzle with brush

- Use by attaching to the inlet of the handy cleaner.

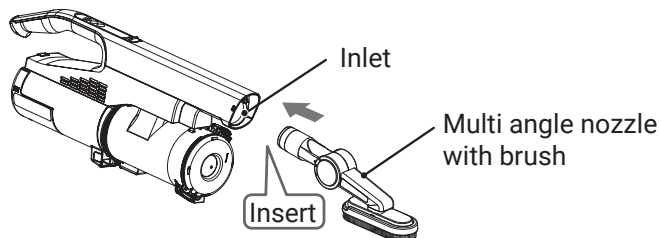

- It is a free rotating nozzle that can reach far above furniture and into crevices.

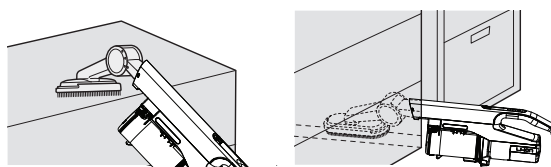

CAUTION

Risk of damage.
Do not press against areas that are particularly easy to be damaged, such as pianos.

- You can change to various angles according to the area to be cleaned.

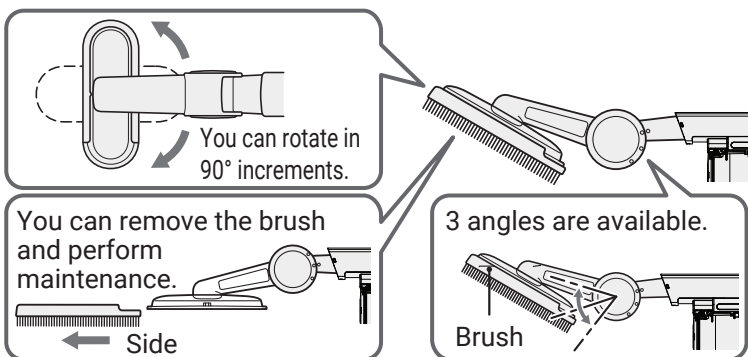

- If you are using the nozzle with the brush removed, use it to collect dust on clothing, curtains, etc.

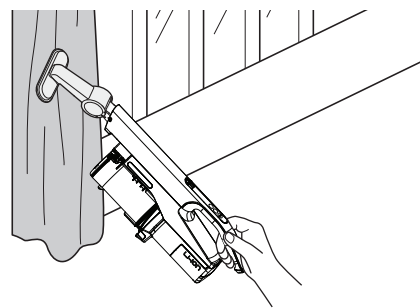

WARNING

Risk of injury.

- When changing the angle, do not hold the rotating section. Your hand may get pinched.
- Do not rotate while your fingers are inserted / into the inlet of the Multi angle nozzle (with brush). Your fingers may get pinched.

Note

- When using the Multi angle nozzle (with brush), do not let it fall or add excessive force in the direction of the arrow **A** in. Doing so may result in damage.
- You can wash the Multi angle nozzle (with brush) with water. After washing, thoroughly air dry before use. Vacuuming water may result in damage.
- If fibrous dust clogs the end or interior of the Multi angle nozzle with brush, suction power is reduced, so remove the dust.

Emptying the dust case and cleaning the filters

Cyclonic cleaners does not require using paper bags as high suction power is used to compress dirt and debris. We recommend disposal of dust and debris after each use, and frequent filter maintenance.

- Empty the dust case before exceeding the “Max line” (guideline). If the “Max line” is exceeded, the dust and debris might be difficult to remove from the dust case.
- Dust and debris might not rotate depending on the type of dust and debris and how it accumulates, which is normal.

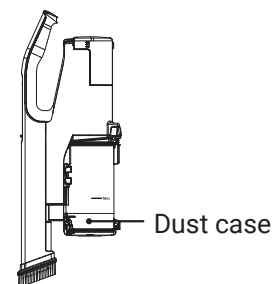

Note Fine dust and debris might disperse in the air when emptying the dust case. Empty the dust case in a well-ventilated environment such as outdoors, or wear a mask and avoid breathing in the dust and debris.

Checking the level of dust and debris in dust case

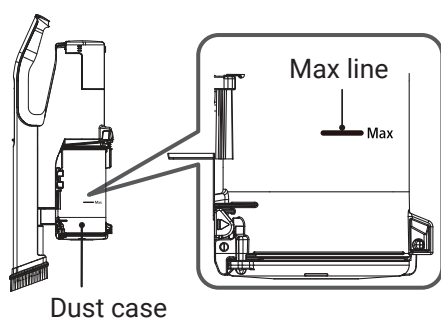

- When dispose the dust and debris from the dust case, remove the dust and debris adhered to the dust case and clean the filter. → (P.EN-20, EN-23)
- If dust and debris is wrapped around the inner cylinder filter and cannot be removed, detach and maintain the inner cylinder filter. → (P.EN-24)

Emptying the dust case [when attached to the vacuum cleaner]

1

1 Tilt the vacuum cleaner and position the dust case to face the trash can.

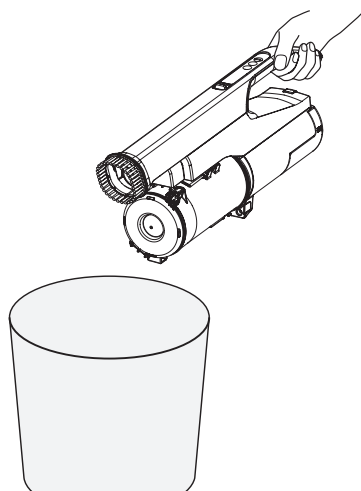

2 Press the disposal button.

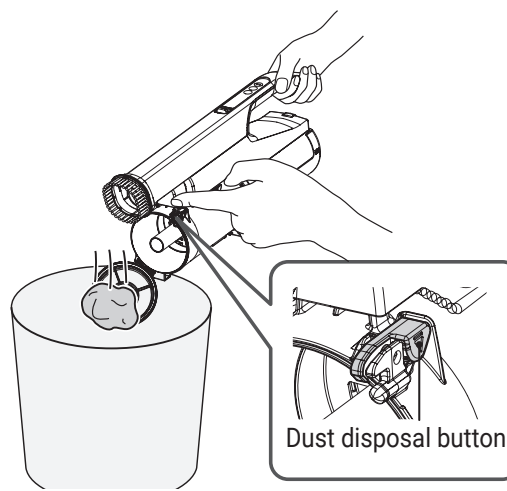

Emptying the dust case (continued)

2 Remove attached dust and debris.

Remove the dust and debris and fine dust and debris using soft cloths, etc.

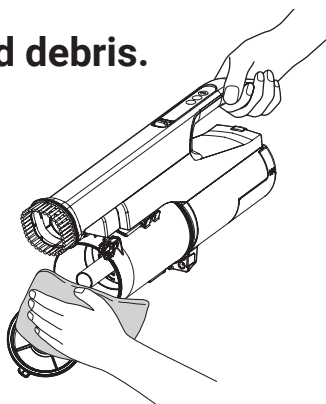

⚠ CAUTION

Risk of damage

You might have unintentionally vacuumed sharp objects such as glass shards or pins. Be careful when performing maintenance.

3 Close the dust case lid.

Close until you hear a "click" sound.

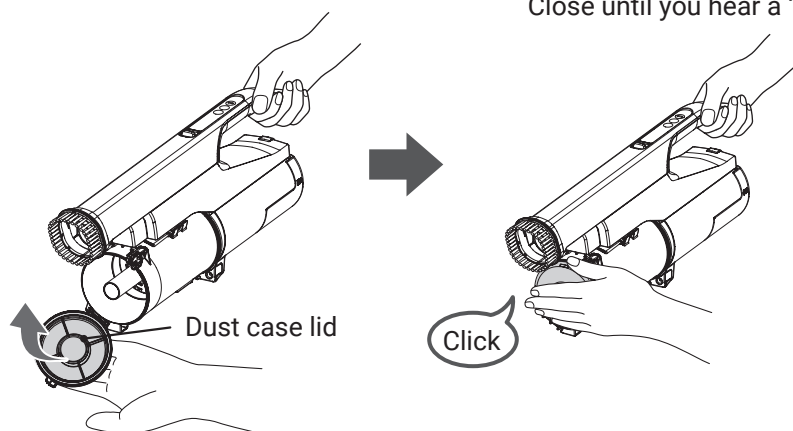

Note

In order to maintain strong sucking power, regularly perform frequent maintenance of the filter. → (P.EN-23, EN-24, EN-27)

Emptying the dust case [when removed from the vacuum cleaner]

1 Hold the dust case and pull the dust case release button.

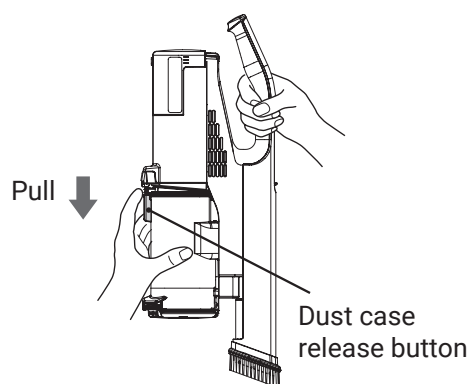

2 Pull out the dust case in the arrow direction.



Note

- Do not detach the dust case with the vacuum cleaner set down. Dust and debris might spill.
- If dust and debris spills inside the vacuum cleaner, remove the dust and debris and attach the dust case as it was.
- Do not turn the dust and debris collection inlet downward when holding the dust case or placing it. Dust and debris might spill.

3

Open the dust case lid and empty the dust case.

Make sure the dust case lid is facing down, and then press the dust disposal button.

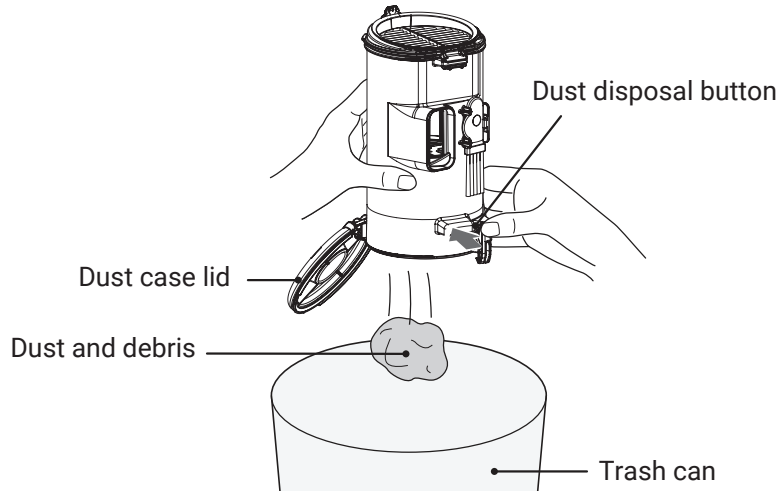

Note

Dust and debris might be hard to remove depending on the type of dust and debris and how it accumulates. Add vibration by tapping the sides of the dust case or detaching the inner cylinder filter.

4

Remove attached dust and debris.

1 Detach the maintenance brush attached to the back side of the dust case.

2 Remove the dust and debris and fine dust and debris with the maintenance brush.

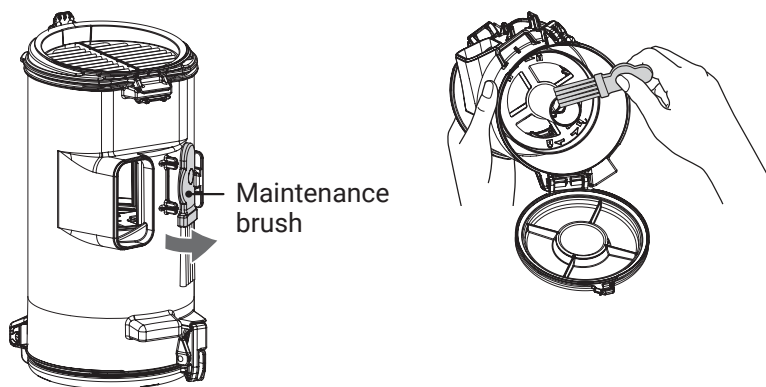

CAUTION

Risk of injury

You might have unintentionally vacuumed sharp objects such as glass shards or pins. Be careful when performing maintenance.

5

Close the dust case lid.

Close until you hear a "click" sound.

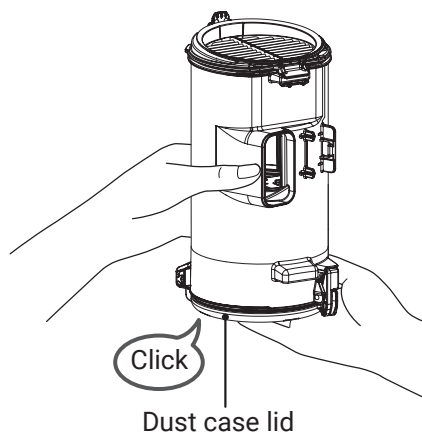

Cleaning the filters

Clean filter

1 Open the clean filter.

1 Set the dust case on the floor.

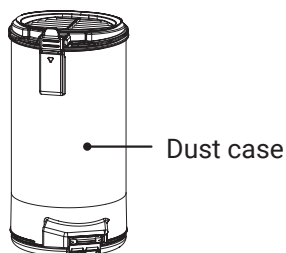

2 Grab and hold the lower part of the dust case, lift up the knobs of the clean filter, and open the cover in the direction indicated by the arrow.

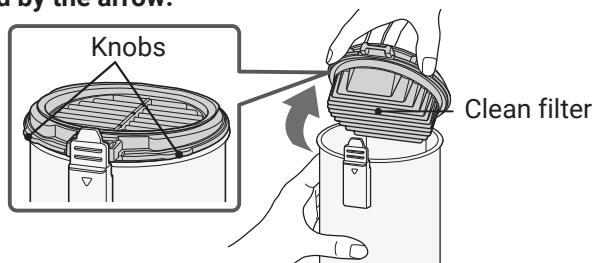

2 Remove dust and debris from the clean filter.

1 Detach the clean filter.

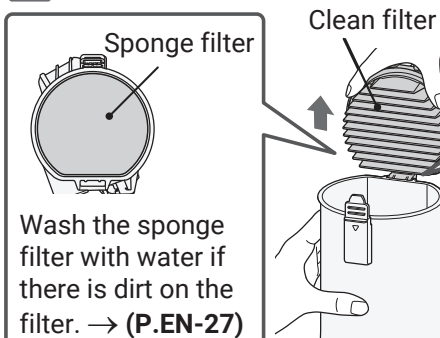

2 Remove attached dust and debris by using the maintenance brush.

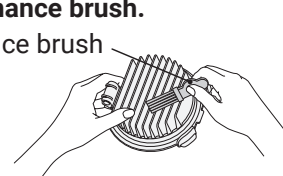
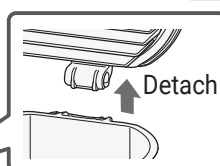

Note

- When removing dust and debris, do not slap the clean filter onto the floor, etc. Failure to do so might cause damage.
- Be sure to attach the sponge filter after emptying the dust case or cleaning the filters.
- To clean the clean filter, use the maintenance brush that was provided with the vacuum cleaner.

Perform maintenance (wash with water) when you are concerned about dirt or the suction power is weak. → (P.EN-27)

3 Attach the clean filter.

Attach the clean filter in the reverse order of removal.

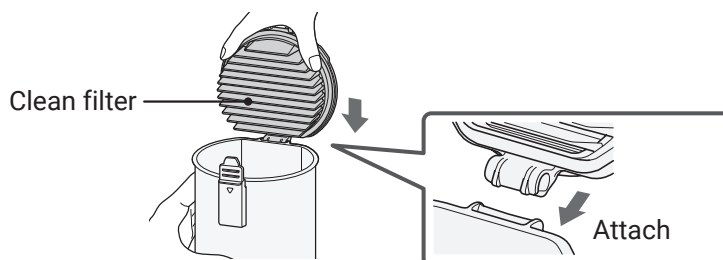

4 Close the clean filter.

Press firmly until you hear a "click" sound.

Note

Make sure the sponge filter is attached.

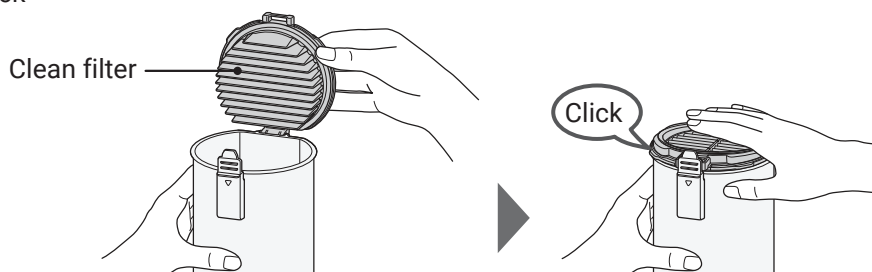

Inner cylinder filter • inner cylinder cap

1 Open the dust case lid → (P.EN-22) and remove the inner cylinder filter.

- 1 Turn the  mark on the cap Turn until it stop
- 2 Lift the inner cylinder filter straight up.

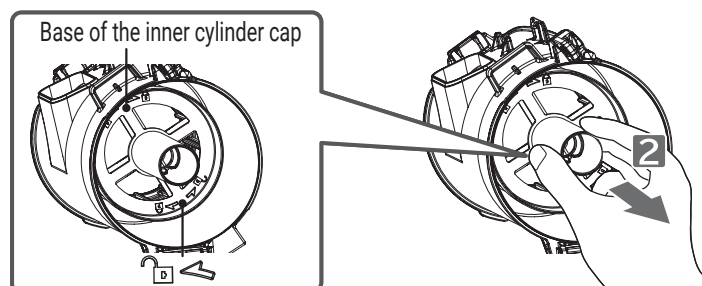

Note

Dust and debris might spill when the dust case is removed. Remove the dust case over a newspaper, etc.

2 Remove dust and debris from the inner cylinder filter.

You can easily remove dust and debris caught in the inner cylinder filter by sliding the maintenance brush in the direction indicated by the arrow.

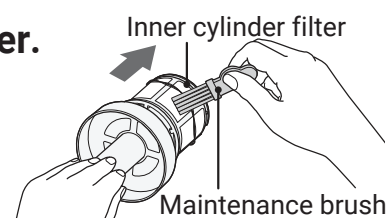

3 Attach the inner cylinder filter and close the dust case lid. → (P.EN-22)

- 1 Inner cylinder fill in the center of the dust case
- 2 Turn the  mark on the cap on the dust case until you hear a "click" sound.

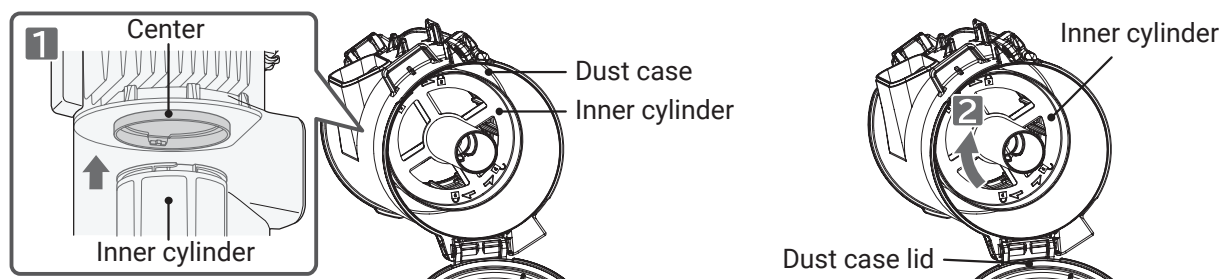

Note If the filter is not securely attached, it might fall when you empty the dust case. Similarly, if you use the vacuum cleaner without securely attaching the filter, strange sounds might come from around the filter.

4 Attach the maintenance brush to the back side of the dust case.

- 1 Attach the maintenance brush to the hook of the dust case.
- 2 Firmly attach the knob of the maintenance brush until you hear a "click" sound.

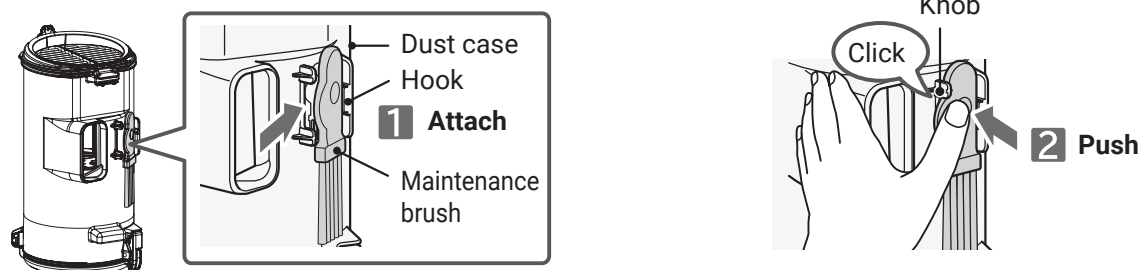

Note If the maintenance brush is not securely attached to the back of the dust case, the brush might fall off when you use the vacuum cleaner. Securely attach the maintenance brush to the back side of the dust case.

Attaching the dust case

Attach the dust case

1 Attach the groove of the dust case to the protrusion of the vacuum cleaner.

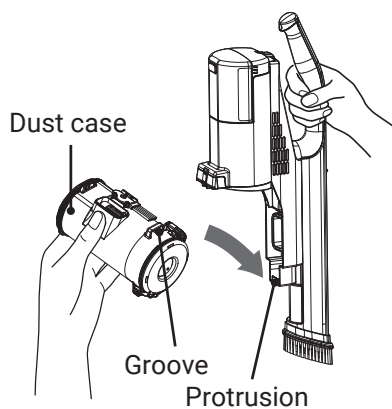

2 Firmly attach the dust case until you hear a "click" sound.

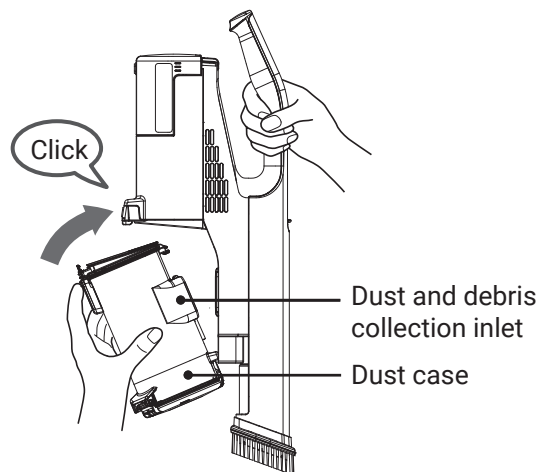

WARNING

Risk of injury

Do not leave the vacuum cleaner leaned up against furniture and place it horizontally on a flat surface.



CAUTION

Risk of injury or damage to the floor.

- When carrying the vacuum cleaner while it is set on the charging station, the vacuum cleaner might detach.
- Do not move the vacuum cleaner on the floor while it is set on the charging station.

Maintenance

To clean with high suction power, we recommend performing frequent maintenance.

Vacuum cleaner, attachments, attachment accessories

Perform maintenance when you are concerned about dirt.
Moisten a soft cloth and then wring it out thoroughly.



WARNING

Risk of eruption, fire, electric shock, or injury.

- When cleaning the charging station, unplug the plug of AC adapter from outlet.
- When cleaning the vacuum cleaner, disconnect the connector of AC adapter from vacuum cleaner.
- Do not use flammable objects, combustibles (thinner, benzene), etc.



CAUTION

Risk of injury

Before performing maintenance on the vacuum cleaner, make sure the vacuum cleaner is turned off.

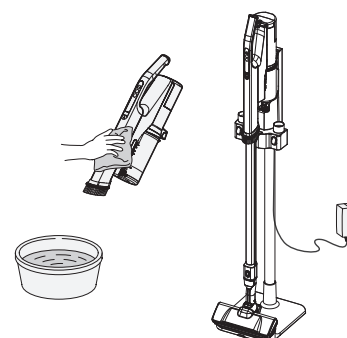

Note

Do not use alcohol, cleansers, chemical dust cloths, etc.
They might cause cracks or discoloration.

Terminals on the vacuum cleaner and on the AC adapter

Stop operating the vacuum cleaner → (P.EN-9), remove the battery from the vacuum cleaner → (P.EN-37), and wipe with a dry soft cloth.

- Disconnect the plug of the AC adapter from the outlet.
- Before performing maintenance on the vacuum cleaner, disconnect the connector of the AC adapter from the vacuum cleaner.

Terminals

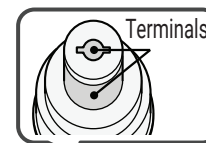
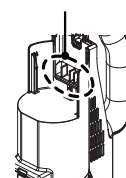

Plug

Connector

AC adapter

Outlet

Washable Parts

You can wash the following parts: 2-way crevice nozzle → (P.EN-18), handy brush → P.EN-16), multi angle nozzle with brush → (P.EN-19), clean filter → (P.EN-27), sponge filter → (P.EN-27), inner cylinder filter and dust case → (P.EN-27 to EN-28), and rotary brushes → (P.EN-30).

Do not wash any other attachments or parts with water.

After washing any attachment or part with water, allow it to dry thoroughly before using it.

About 24 hours is required for the clean filter and sponge filter to dry.

(The drying time varies depending on the environment and season.)

Note

During maintenance, fine dust and debris might disperse into the air. Perform maintenance in a wellventilated environment (for example, outdoors) or wear a mask to avoid breathing in the dust and debris.

Maintaining (washing with water) the filters

Wash the filters with water, if the filter indicator blinks in red or the vacuum cleaner's suction power is weak.

Clean filter, sponge filter

1 Wash the filters with water by using the maintenance brush.

- Gently remove any attached dust and debris from the filters before washing them with water.
- Detach and then wash the clean filter with water → (P.EN-23)
- When washing the clean filter with water, thoroughly remove any dust and debris stuck in its folds.

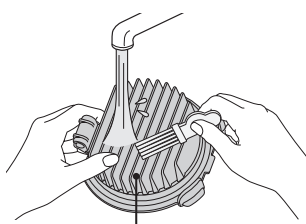

Clean filter

⚠ CAUTION

Risk of injury

You might have unintentionally vacuumed sharp objects such as glass shards or pins. Be careful when performing maintenance.

Note

To clean the clean filter, use the maintenance brush that was provided with the vacuum cleaner.

2 To wash the sponge filter, gently squeeze the sponge filter while holding it under running water.

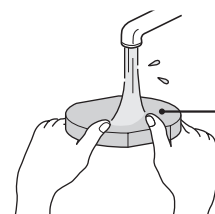

Sponge filter

3 Air dry the filter.

- Drying the clean filter and the sponge filter requires approx. 24 hours. (The drying time varies depending on the environment and season.)
- Also, do not dry it with hot air such as that from a hair dryer. Doing so might cause a performance degrade, damage, or deformation.

4 Attach the sponge filter.

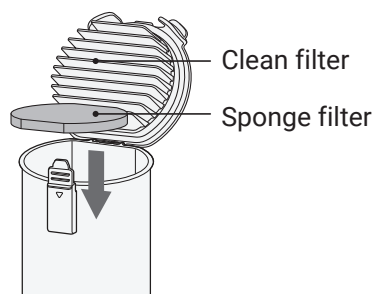

Clean filter

Sponge filter

Note

- Be sure to attach the sponge filter. If you do not attach the sponge filter, the clean filter might become clogged after a short period of use or the vacuum cleaner might make strange sounds.
- After washing the filter with water, allow it to thoroughly air dry before you reassemble it. Do not use them without drying. Doing so might clog the filters soon and cause weak suction power or abnormal odor.

5 Attach the clean filter.

Attach the reverse order of removal. → (P.EN-23)

Inner cylinder filter • inner cylinder cap

1 Remove the inner cylinder filter. → (P.EN-24)

2 Wash the inner cylinder filter and dust case with water.

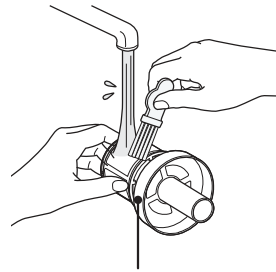

Inner cylinder filter

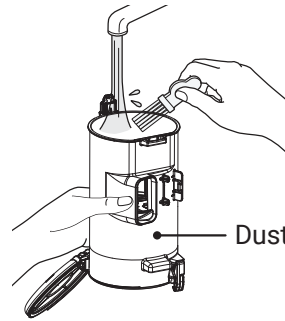

Dust case

Note

- Gently remove any attached dust and debris from the filters before washing them with water.
- Drain the water attached to the inner cylinder filter thoroughly after washing.

3 Air dry the filter.

- After washing the filter, allow it to thoroughly air dry before you reassemble it. Do not use it without drying. Doing so might clog the filters soon and cause weak suction power or abnormal odor.
- Also, do not dry it with hot air such as that from a hair dryer. Doing so might cause a performance degrade, damage, or deformation.

4 Attach the inner cylinder filter. → (P.EN-24)



CAUTION

Risk of damage to the vacuum cleaner

Attach the dust case and filters before operation.

If any dust and debris enters the motor, the filter inside the vacuum cleaner might be clogged and strange sounds might come from the vacuum cleaner.

In this case, please consult a Hitachi authorized service agent.

Note

If the suction power is weak even after washing the filters with water, the clean filter, sponge filter, etc. might be worn.

To request replacement, please contact a Hitachi authorized service agent.

Cleaning the power heads

Maintaining the power head

- Perform maintenance when suction power is weak or when dirt becomes a concern.
- We recommend periodic maintenance (about once a month).
Dust and debris stuck to the safety switch, rotary brush, brushes, wheels, air inlet, and rotating sections might cause reductions in suction power or malfunctions.



CAUTION

Risk of injury

Before performing maintenance, detach the power head from the vacuum cleaner or extension pipe and smart hose.

Remove attached dust and debris

Remove the attached dust and debris by using the 2-way crevice nozzle or other tools.

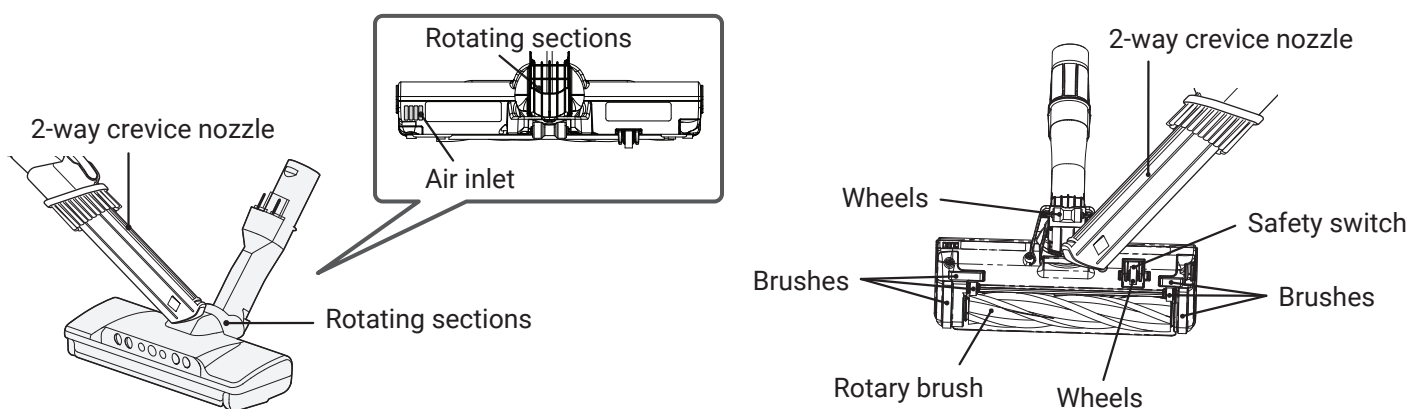

Remove tangled dust and debris

Remove tangled dust and debris using tweezers, etc.

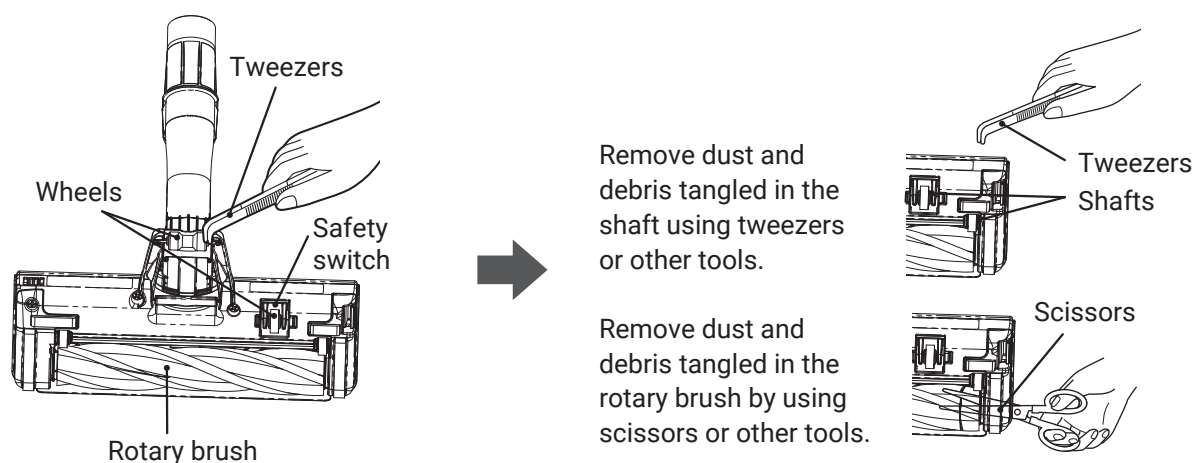

CAUTION

Risk of damage to the floor

- If dust and debris gets tangled in the wheels, the wheels cannot rotate, which might cause wear and tear and floor damage.
- After extended use, the brushes, wheels, and rotary brush might wear down. Using the power head while they are worn out might damage the floor. You cannot replace the brushes or wheels by yourself. Please contact a Hitachi authorized service agent to have the brushes, wheels, and rotary brush replaced as a set.

Note

Do not subject the safety switch to excessive force. Failure to do so might cause damage.

Rotary brush maintenance

1 Remove the brush holder.

1 Flip over the power head and open the lever.

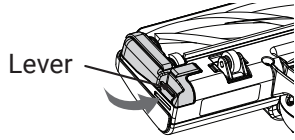

2 Remove the brush holder.

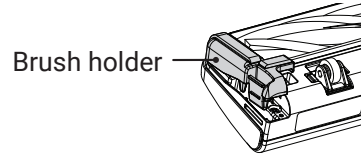

2 Detach the rotary brush and remove dust and debris.

Remove dust and debris

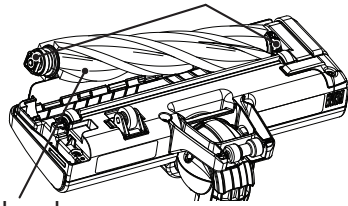

Remove dust and debris tangled in the groove using tweezers, etc.

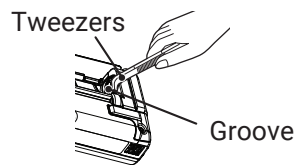

Remove dust and debris tangled in the rotary brush by using scissors.

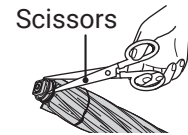

To wash the rotary brush with water

1 Wash with water.

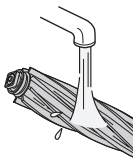

2 Shake to remove excessive water.

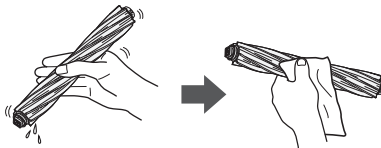

3 Thoroughly air dry.

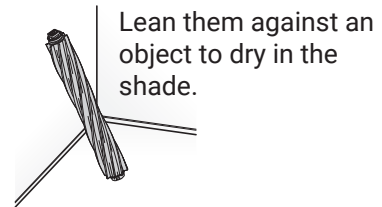

Note

- Do not use cleansers, bleach, etc. Doing so might cause discoloration, deformation, etc.
- After washing with water, thoroughly air dry it in the shade before attaching it. Drying it requires approx. 24 hours. (The drying time varies depending on the environment and season.)

3 Adjust the rotary brush with the groove and attach it to its original position.

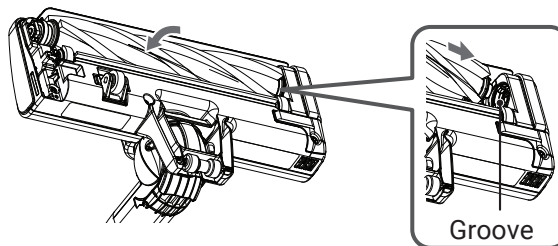

4 Attach the brush holder.

1 Insert the hook.

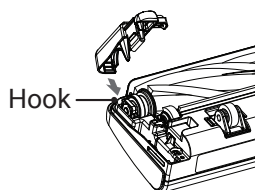

2 Attach the brush holder.

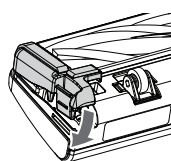

3 Close the lever.

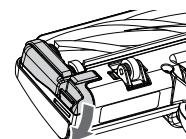

Note

When attaching the brush holder, fasten the hook first. Failure to do so might cause damage.

Maintaining the mini power brush

- Perform maintenance when suction power is weak or when dirt becomes a concern.
- We recommend periodic maintenance (about once a month).
Dust and debris stuck to the safety switch, rotary brush, brushes, wheels and rotating sections might cause reductions in suction power or malfunctions.



CAUTION

Risk of injury

Before performing maintenance, detach the mini power brush from the vacuum cleaner or extension pipe and smart hose.

Remove attached dust and debris

Remove the attached dust and debris by using the 2-way crevice nozzle or other tools.

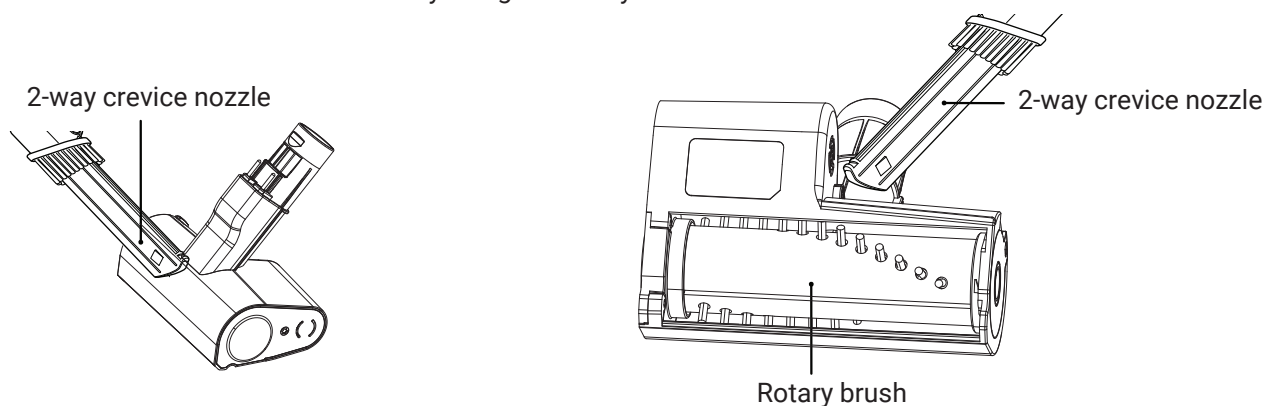

Remove tangled dust and debris

Remove tangled dust and debris using tweezers, etc.

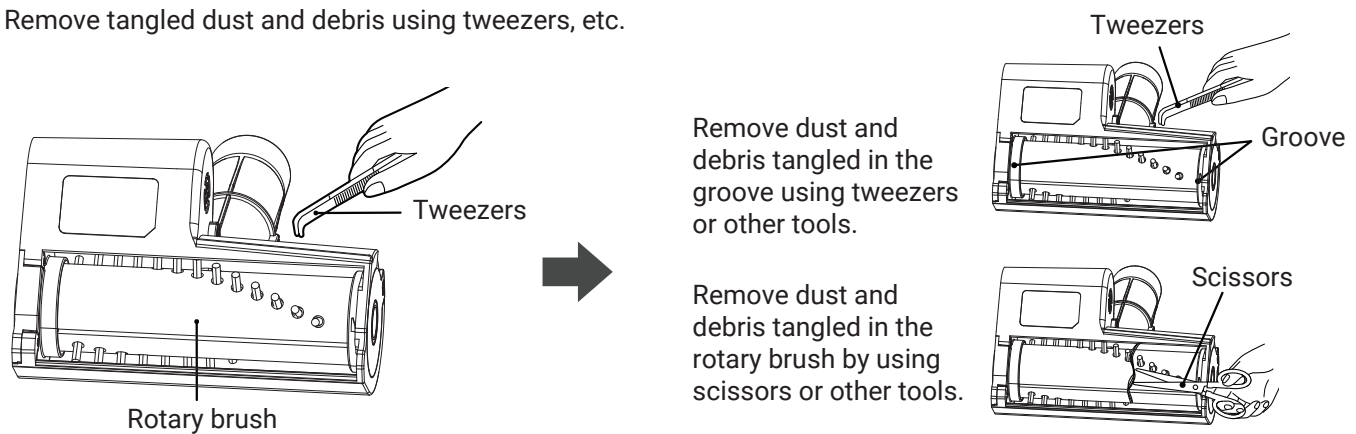

CAUTION

Risk of damage

Do not press against areas that are particularly easy to be damaged, such as pianos.

Rotary brush maintenance

1 Remove the brush holder.

- 1 Flip over the mini power brush and turn on the cover.

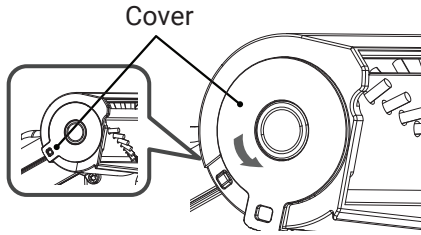

2 Detach the rotary brush and remove dust and debris.

Remove dust and debris

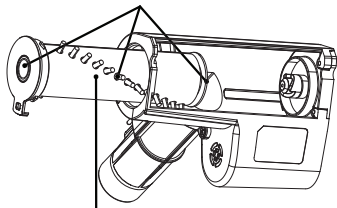

Rotary brush

Remove dust and debris tangled in the groove using tweezers, etc.

Tweezers

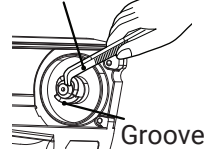

Groove

Cut and remove dust and debris tangled in the rotary brush using scissors, etc.

Scissors

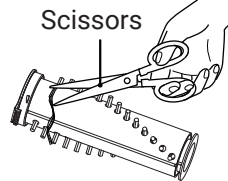

The rotary brush can be washed with water.

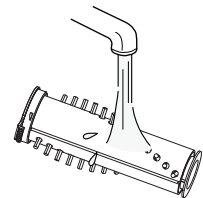

Note

- Do not use cleansers, bleach, etc. Doing so might cause discoloration, deformation, etc.
- If the rotary brush has been washed with water, attach it after thoroughly drying it naturally in the shade. Drying it requires approx. 24 hours. (The drying time may differ depending on the environment or season.)

3 Adjust the rotary brush with the groove and attach it to its original position.

- 1 Adjust the rotary brush with the groove.

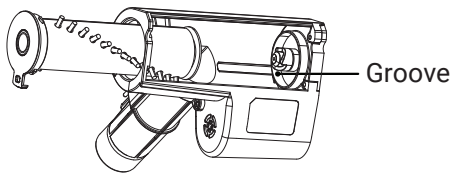

Groove

- 2 Attach it to its original position.

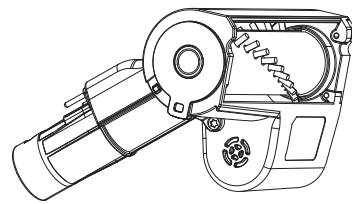

4 Attach the brush holder.

- 1 Push the cover to firmly.

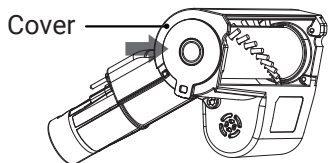

Cover

- 2 Turn off the cover.

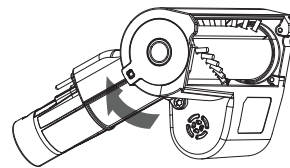

Note

When attaching the brush holder, fasten the hook first. Failure to do so might cause damage.

Troubleshooting

Before requesting for repair

Check the following points again

The vacuum cleaner does not operate, or stops while the vacuum cleaner is running. The suction power is weak. The rotary brush does not rotate.

The safeguard might be operating. Release the safeguard with the following instructions.

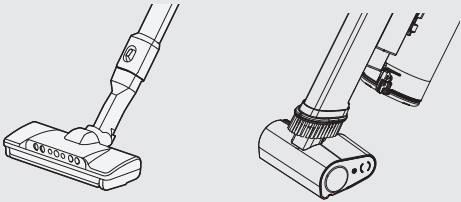

Suction power of the vacuum cleaner becomes weak or stops while the vacuum cleaner is running.		The rotary brush of the power head or mini power brush stops.		
Safeguard and cause	<p>To prevent the vacuum motor or the battery from overheating, the vacuum cleaner might sometimes automatically enter safe mode, in which the vacuum cleaner runs with less electricity and reduced suction power.</p> 	<p>If the vacuum cleaner is continuously operated in a state where there is a lot of resistance to the rotary brush, the rotation of the rotary brush stops automatically to prevent the motor from overheating.</p> 		
	<p>The filter indicator is blinking (about two times per second).</p>	<p>Filter indicator is off, or the battery indicator is blinking slowly (about once per two seconds).</p>	<p>The filter indicator is blinking (about two times per second).</p>	<p>Filter indicator is off.</p>
	<p>Dust and debris clogged in clean filter or sponge filter → ①</p> <p>Operation while blocking the inlet → ②</p>	<p>The battery is hot → ③</p> <p>The vacuum cleaner motor is hot → ③</p>	<p>Dust and debris clogged in clean filter or sponge filter → ①</p> <p>Operation while blocking the inlet → ②</p>	<p>Foreign substance stuck in vacuum cleaner → ④</p> <p>Power head pressed against the area to clean → ⑤</p>

If the vacuum cleaner continues to operate further, it stops automatically.

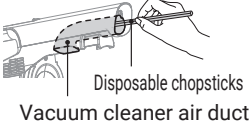

Press the  button of the vacuum cleaner to stop operation.					
Instructions	①	②	③	④	⑤
	<p>Empty the dust case or maintain the dust case or filters. → (P.EN-20~EN-24, EN-27~EN-28)</p>	<p>Remove the object that is blocking the inlet.</p>	<p>Let the vacuum cleaner cool down. (It might take some time before the vacuum cleaner cools down.)</p>	<p>Remove the foreign substance from the rotary brush → (P.EN-29~EN-30)</p>	<p>Do not firmly press the power head against the floor or carpet.</p>

The safeguard is released after 5 to 60 minutes, and you can use the cleaner normally.

Other problems

Problem	Things to check	Instructions	Page
Suction power becomes weak or stops during operation.	Is the remaining battery level low? [Battery indicator is blinking (about once times per second)]	Charge the vacuum cleaner by setting the vacuum cleaner on the charging station or by connecting the AC adapter to the vacuum cleaner.	P.EN-12
	Is the exhaust abnormally hot?	Stop operation by pressing the control button. Wait for the vacuum cleaner to cool down, and then start operation again.	—
	Is the battery indicator blinks slowly (about once per four seconds)?		
	When continuously operating in places of high temperature, such as under direct sunlight or in cars exposed to the sun, the safeguard might operate and the suction power might become weak to prevent the vacuum cleaner motor and battery from overheating.		
Suction power becomes weak or stops during operation. (Filter indicator is blinking.) The operation sound increased.	Is the dust case full of dust and debris?	Empty the dust case.	P.EN-20-EN-22
	Is dust and debris stuck in the filters?	Clean the filters (wash with water).	P.EN-23-EN-25 EN-27-EN-28
	Is dust and debris clogging the vacuum cleaner air duct?	Remove the dust and debris using disposable chopsticks, etc. 	—
	Is dust and debris clogging the power head or mini power brush?	Remove the dust and debris.	P.EN-29 to EN-30
	Did you vacuum fine sand or dust and debris?	Empty the dust case and perform maintenance (wash with water) on the filters.	P.EN-20 to EN-24 EN-27-EN-28
The cleaner does not operate, or stops during operation	Is the remaining battery level low?	Charge the battery.	P.EN-12
	Is the vacuum cleaner being charged?	Remove the vacuum cleaner from the charging station or disconnect the AC adapter.	—
Operating time is short even after charging	Is the room temperature lower than 5°C or higher than 35°C?	When using the vacuum cleaner or charging the battery, make sure the ambient temperature is between 5°C and 35°C.	P.EN-13
	Are you using the vacuum cleaner in a cold place?	Leave the vacuum cleaner in an area where the ambient temperature is between 5°C and 35°C. Wait for the vacuum cleaner to warm up, and then try again.	—
	Did you leave the vacuum cleaner unattended for a long period of time without charging it?	The battery capacity might be temporarily recovering poorly. Repeat the procedure of using the cleaner until the battery is exhausted and charging fully 2 or 3 times.	P.EN-13
	Is the battery exhausted?	If the vacuum cleaner stops running after a short time even though it is fully charged and the filters are clean (wash with water), you might need to replace the battery. Please consult with a Hitachi authorized service agent.	P.EN-20 to EN-24 EN-27-EN-28
The exhaust or vacuum cleaner gets warm (during operation)	The motor is being cooled via air flow, which is normal.		—
The vacuum cleaner or AC adapter gets warm (during charging).	It gets warm due to the flow of electrical current to the control circuit, which is normal.		—
The exhaust smells strange.	Is dust and debris stuck in the filters?	Perform maintenance for (wash with water) each filter.	P.EN-27-EN-28
	Are the filters thoroughly dried after washing?	After washing with water, thoroughly air dry the filters.	
There are abnormal sounds coming from around the dust case.	Are the clean filter and dust case securely attached?	Securely attach them.	P.EN-23 to EN-25
	Is dust and debris clogging the vacuum cleaner air duct?	Remove the dust and debris using disposable chopsticks, etc. 	—

Problem	Things to check	Instructions	Page
The dust and debris of the dust case does not rotate	Dust and debris might not rotate depending on the type of dust and debris and how it accumulates, which is normal.		-
Dust and debris spills out of the vacuum cleaner when the dust case is removed.	Has the dust and debris in the dust case exceeded the max line of the dust case?	Dispose the dust and debris before it exceeds the max line of the dust case.	P.EN-20 to EN-22
Dust and debris spills out when attachments are removed.	Has the dust and debris in the dust case exceeded the max line of the dust case?	Dispose the dust and debris before it exceeds the max line of the dust case.	P.EN-20 to EN-22
	If operation is stopped while the vacuum cleaner is in operation facing upwards, dust and debris might remain in the vacuum cleaner air duct. Stop operation while the vacuum cleaner is facing downwards.		-
The rotary brush of the power head or mini power brush stops or rotates poorly.	Is the remaining battery level low? [Battery indicator blinks (about once times per second)]	Charge the battery.	P.EN-12
	Are the power head or mini power brush securely attached?	Securely attach it.	P.EN-7
	Did you lift the power head off of the surface (floor or fabric) to be cleaned?	The power head are designed to stop rotating when they are not in contact with a surface to be cleaned. Make sure the power head is in contact with the surface to be cleaned.	P.EN-15 EN-17
	Is dust and debris stuck to the rotary brush, safety switch, etc.?	Remove the dust and debris.	P.EN-29 to EN-30
The rotary brush of the power head stops, or the (LED lights turn off.) The filter indicator blinks.	The rotary brush might stop automatically to prevent the power head motor from overheating.	Empty the dust case and perform maintenance (wash with water) on the filters. Remove the object that is blocking the inlet.	P.EN-20 to EN-24 EN-27-EN-28
The rotary brush of the mini power head stops.	The rotary brush might stop automatically to prevent the motor from overheating. The safeguard is released after 5 to 60 minutes automatically.		P.EN-33
Tick sound when moving the power head	This is the sound that occurs due to the structure of the power head. This is normal.		-
LED lights are dim	Is the remaining battery level low?	Charge the battery.	P.EN-12
There is a clattering sound coming from the power head or mini power brush	This sound is produced because of the way the safety switch is designed. The sound does not indicate a problem with the product.		-
The battery Indicator does not turn on (remains off) even after the vacuum cleaner is charged.	Is the AC adapter firmly plugged into the outlet?	Firmly insert the plug.	P.EN-12
	Is the connector of the AC adapter firmly inserted into the vacuum cleaner?	Firmly insert the connector.	
	Is the battery fully charged?	When fully charged, the battery Indicator turns off.	-
	Are the terminals on the AC adapter or vacuum cleaner dirty?	Unplug the plug and remove the battery, and remove the dust and debris on the terminals with a dry cloth.	-
	Did you not use the vacuum cleaner and leave it unattended for a long period of time without charging it? When leaving it unattended, the battery might have to be replaced because its performance and life might be deteriorated. Please consult with the Hitachi authorized service agent.		-

Problem		Things to check	Instructions	Page
Display blink 	Blink quick while charging (about two time per second)	Are you using the AC adapter that was provided with the vacuum cleaner?	Do not use AC adapter other than the one that was provided with the vacuum cleaner.	P.EN-38
		Is the room temperature lower than 5 °C or higher than 35 °C?	Charge in areas where the room temperature is between 5 °C and 35 °C.	P.EN-6
	If the above measures do not fix the problem, either the battery is consumed, or the battery or charging station is damaged. Please consult with the Hitachi authorized service agent.			
	Blink slowly during operation (about once per four seconds)	This is a notice of protective operation to prevent overheating of the vacuum cleaner's motor and battery.	Wait for the vacuum cleaner to cool down, and then start operation again.	—
Display blink  + 	Blink quick at the same time while charging (about two time per second)	Is the battery correctly attached to the vacuum cleaner?	Remove the vacuum cleaner from the charging station or AC adapter connector, attach the battery securely to the vacuum cleaner, and set it back on the charging station or insert the AC adapter connector into the vacuum cleaner.	P.EN-12
		If the above measures do not fix the problem, either the battery is consumed, or the battery or charging station is damaged. Please consult with the Hitachi authorized service agent.		—
	Blink quick at the same time while driving (about two time per second)	Is the battery correctly attached to the vacuum cleaner?	Correctly attach the battery to the vacuum cleaner and start the operation again.	P.EN-37
If the above measures do not fix the problem, either the battery is consumed, or the battery or vacuum cleaner is damaged. Please consult with the Hitachi authorized service agent.		—		
		Did the vacuum cleaner not heat up when the connector of the AC adapter was insert into the terminal of the vacuum cleaner?	This is not an error because the protective device has been activated. When charging is complete, the battery indicator lamp will turn off.	—
It takes a long time to charge.	Charging time of battery might be longer according to the usage environment and conditions such as the ambient temperature and usage frequency.		—	
	If the battery indicator doesn't disappear even after charging the battery for over 7 hours, the device might be damaged, so please consult with the Hitachi authorized service agent.		—	
If you touch the vacuum cleaner , it will startle.	Static electricity may be generated by inhaling dust, but this is not a malfunction. If it occurs frequently, please consult with the Hitachi authorized service agent.		—	
If the problem persists			Do not attempt to repair it yourself. Please contact a Hitachi authorized service agent.	—

Replacing the battery and disposing of the vacuum cleaner

 **DANGER**



- **Do not connect the battery to devices other than this vacuum cleaner. Also, do not disassemble, modify, or solder the battery, or charge the battery on its own.** Failure to heed this warning might cause the battery to leak, generate heat, rupture, smoke, fire, electric shock, or injury.
- **Do not detach the battery while the vacuum cleaner is in operation.** Failure to heed this warning might cause smoke, fire, electric shock, or injury.

Replacing the battery

The battery is a consumable item. When the usage time of the battery becomes short even when properly charging, the life of the battery has reached its end. Please replace the battery. Consult with your Hitachi authorized service agent when replacing the battery without disposing of the product due to the life of the battery reaching its end, etc.

Replacing the battery and disposing of the vacuum cleaner (continued)

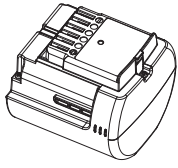

- Battery exclusive for the Hitachi electric vacuum cleaner Model: PVB-2525A

Note

If a battery other than the exclusive battery is used, the performance and quality of the vacuum cleaner is not guaranteed.

Replacement of the battery

1 Detach the attachments → (P.EN-14) from the vacuum cleaner.

2 Detach the battery.

Hold the handle, pull the battery release button in the direction of the arrow, hold the side of the battery, and pull it out in the direction of the arrow.

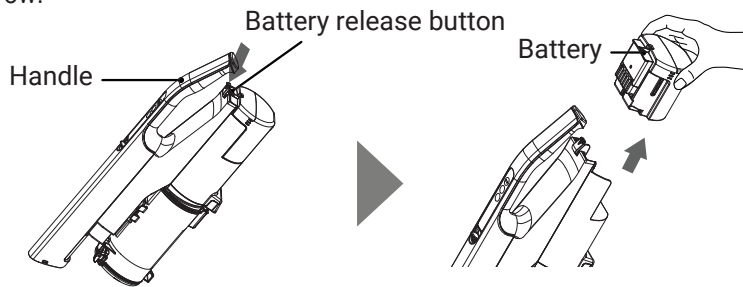

CAUTION

Risk of injury

Do not let your finger stick out from the battery release button when removing the battery.

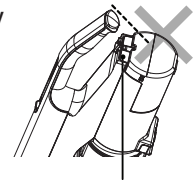

Battery release button

3 Attaching the new battery.



WARNING

Correctly attach the battery to the vacuum cleaner.

Doing so might cause heat to be generated, a fire, or an electric shock.

Disposing of the vacuum cleaner

To prevent damage to property and personal injury, please thoroughly read the Safety precautions → (P.EN-2 to EN-6) and dispose the product properly.

Recycling the battery (when disposing the product)

This product uses a lithium-ion battery.

Lithium-ion batteries are a valuable, recyclable resource.



To dispose of the vacuum cleaner, detach the battery according to the following procedure, and then bring the vacuum cleaner to a Hitachi authorized service agent or one of our recycling partner stores. Alternatively, ask local authorities about the proper method of disposing of the vacuum cleaner, and follow your local recycling regulations.

*Recycling rules might vary depending on the local authorities.

Detaching the battery (When disposing of the product)

Follow the procedure 1 to 2 of the replacement of the battery. Insulate the battery terminal by attaching vinyl tape.

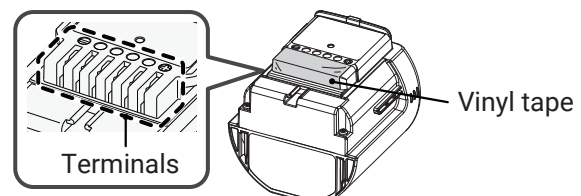

Specifications

Product name		Cordless Stick Cleaner Vacuum Cleaner	
Model name		PV-XH3M	
Body	Rated voltage	DC25.2V	
	Nominal capacity	2,100 mAh.	
	Dust bin capacity	0.5 L	
	Dust capacity (Max line)	0.4 L	
	Battery	Lithium-ion battery (7 cells)	
	Continuous operating time*	Standard: Approx. 40 minutes (with Power head) Standard: Approx. 60 minutes (without Power head) High : Approx. 15 minutes Turbo : Approx. 6 minutes Auto: Approx. 15 minutes to 40 minutes (At full charge, new battery, 20°C)	
	Dimensions	Stick cleaner (L × W × H)	250 mm × 230 mm × 1,215 mm
		Handy cleaner (L × W × H)	181 mm × 90 mm × 463 mm
Weight	Stick cleaner	1.8 kg.	
	Handy cleaner	1.3 kg.	
AC adapter	Input	AC 100-240V, 50/60Hz, 1.0A	
	Output	DC 29.9V, 0.9A	
	Charge time	Approx. 2.5 hours (Varies depending on room temperature and operating time, etc)	
	Cord length	1.6 m.	
Charging station	Outer dimensions (L × W × H)	256 mm × 230 mm × 1060 mm	
	Weight	2.6 kg.	
Attachments		Power Head 1 pc. Extension pipe 1 pc. AC adapter*1 1 pc. Wall bracket 1 pc. Stand pipe 1 pc. Stand base 1 pc.	
Attachment accessories		Handy brush 1 pc. 2-way crevice nozzle 1 pc. Mini power brush 1 pc. Multi angle nozzle with brush 1 pc.	

Note: * The battery life varies depending on the ambient temperature and other condition under which the vacuum cleaner is used.

*1 : PVA-J299090-UK : Type-G plug shape
PVA-J299090-EU : Type-F plug shape